

California Electronic Medical Billing and Payment Companion Guide

**California Division of Workers' Compensation
Electronic Medical Billing and Payment Companion Guide**

Version 1.0

~~2010~~ 2012



California Electronic Medical Billing and Payment Companion Guide

Purpose of the California Division of Workers' Compensation Electronic Medical Billing and Payment Companion Guide

This guide has been adopted in Title 8, California Code of Regulations section 9792.5.1 as part of the Division of Workers' Compensation billing regulations. It has been created for use in conjunction with national standard implementation guides of the Accredited Standards Committee (ASC X12), and the National Council for Prescription Drug Programs (NCPDP) which have been adopted by the U.S. Secretary of Health and Human Services for use pursuant to the Health Insurance Portability and Accountability Act of 1996 (HIPAA). Specified ASC X12 and NCPDP electronic standards have been incorporated by reference into this guide.

The California Electronic Medical Billing and Payment Companion Guide is not to be a replacement for the national standard implementation guides but rather is to be used as a supplement to the national guides. This companion guide supplements the national guides by providing clarifications and specialized instructions derived from specific business rules that apply to processing bills and payments electronically within California's workers' compensation system.

Other Important Billing Rules

Other important billing rules are contained in:

The California Division of Workers' Compensation Medical Billing and Payment Guide.

Billing Regulations: Title 8, California Code of Regulations section 9792.5.0 et seq.

California Companion Guide Contact Information

Division of Workers' Compensation, Medical Unit

P.O. Box 71010

Oakland, CA 94612

Attn: Electronic Billing

(510) 286- 3700 phone (510) 286-0693 FAX

<http://www.dir.ca.gov/dwc/MedicalUnit/imchp.html>

California Electronic Medical Billing and Payment Companion Guide

Table of Contents

Chapter 1 Introduction and Overview	1
1.1 HIPAA	1
1.2 California Labor Code § 4603.4	1
Chapter 2 California Workers' Compensation Requirements	2
2.1 Compliance	2
2.1.2 Agents	2
2.1.3 Confidentiality of Medical Information Submitted on Electronic Claims/ Security	2
2.2 National Standard Formats	2
2.2.1 California Prescribed and Optional Formats	3
2.2.2 Source of Prescribed Formats	6
2.2.3 Summary of Adopted Formats and Correlation to Paper Form	7
2.2.4 Optional Formats	7
2.3 Companion Guide Usage	7
2.4 Description of ASC X12 Transaction Identification Numbers	8
2.4.1 Sender/Receiver Trading Partner Identification	8
2.4.2 Claims Administrator Identification	8
2.4.3 Health Care Provider Identification	9
2.4.4 Injured Employee Identification (Member ID Number)	9
2.4.5 Claim Identification	9
2.4.6 Bill Identification	9
2.4.7 Document/ Attachment Identification	9
2.5 Claims Administrator Validation Edits	10
2.6 Description of Formatting Requirements	11
2.6.1 Hierarchical Structure	11
2.7 Description of Transmission/Transaction Dates	11
2.8 Description of Code Sets	11
2.9 Participant Roles	12
2.9.1 Trading Partner	12
2.9.2 Sender	12
2.9.3 Receiver	12
2.9.4 Employer	12
2.9.5 Subscriber	12
2.9.6 Insured	12
2.9.7 Injured Employee	13
2.9.8 Patient	13
2.10 Health Care Provider Agent/Claims Administrator Agent Roles	13
2.11 Duplicate, Appeal/Reconsideration and Corrected Bill Resubmissions	13
2.11.1 Claim Resubmission Code - ASC X12N 005010X222, 005010X223, 005010X224 Billing Formats	13
2.11.2 Duplicate Bill Transaction Prior to Payment	14
2.11.3 Corrected Bill Transactions	14
2.11.4 Appeal/Reconsideration Bill Transactions	15
2.12 Balance Forward Billing	17
2.13 California-Specific Requirements that Relate to Multiple Electronic Formats	17
2.13.1 Claim Filing Indicator	17
2.13.2 Transaction Set Purpose Code	17
2.13.3 Transaction Type Code	17
2.13.4 NCPDP Telecommunication Standard D.0 Pharmacy Format and NCPDP Batch Standard 1.2	17
2.13.5 Jurisdictional State Code: Compliance State Identification	17

California Electronic Medical Billing and Payment Companion Guide

Chapter 3 ASC X12N/005010X222 Health Care Claim: Professional (837) ----- 19

3.1 Reference Information ----- 19

3.2 Trading Partner Agreements----- 19

3.3 Workers' Compensation Instructions for ASC X12N/005010X222 Health Care Claim: Professional (837)----- 19

3.3.1 ASC X12N/005010X222 Health Care Claim: Professional (837)----- 21

Chapter 4 ASC X12N/005010X223 Health Care Claim: Institutional (837) ----- 24

4.1 Reference Information ----- 24

4.2 Trading Partner Agreements----- 24

4.3 Workers' Compensation Instructions for ASC X12N/005010X223 Health Care Claim: Institutional (837) ----- 24

4.3.1 ASC X12N/005010X223 Health Care Claim: Institutional (837)----- 27

Chapter 5 Companion Guide ASC X12N/005010X224 Health Care Claim: Dental (837) ----- 29

5.1 Reference Information ----- 29

5.2 Trading Partner Agreements----- 29

5.3 Workers Compensation Instructions for ASC X12N/005010X224 Health Care Claim: Dental (837) ----- 29

5.3.1 ASC X12N/005010X224 Health Care Claim: Dental (837) ----- 31

Chapter 6 Companion Guide Pharmacy NCPDP D.0 ----- 34

6.1 NCPDP Reference----- 34

6.2 Trading Partner Agreements----- 34

6.3 Pharmacy Invoice Number----- 34

6.4 Billing Date ----- 34

6.5 Dispensing Pharmacy Billing and Pharmacy Billing Agents----- 34

6.6 Fill Number v. Number of Fills Remaining ----- 35

6.7 Compound Medications ----- 35

6.8 Brand v. Generic ----- 35

6.9 Prescribing Physician ----- 35

6.10 California Pharmacy Workers' Compensation Instructions ----- 35

6.10.1 NCPDP Telecommunication Standard Implementation Guide D.0----- 35

Chapter 7 Companion Guide ASC X12N/005010X221 Payment/Advice (835)----- 38

7.1 Reference Information ----- 38

7.2 Trading Partner Agreements----- 38

7.3 Claim Adjustment Group Codes----- 38

7.4 Claim Adjustment Reason Codes----- 39

7.4.1 Claim Adjustment Reason Codes 191, 214, 221, W1 ----- 39

7.5 Remittance Advice Remark Codes----- 40

7.6 California Jurisdictional EOR Statement ID Qualifier----- 40

7.7 Product/Service ID Qualifier ----- 41

7.8 California 835 Workers' Compensation Instructions----- 41

7.8.1 ASC X12N/005010X221 Health Care Claim Payment/Advice (835) ----- 41

Chapter 8 Companion Guide ASC X12N/005010X210 Additional Information to Support a Health Care Claim or Encounter (275) (Documentation/Medical Attachment) ----- 44

8.1 Reference Information ----- 44

California Electronic Medical Billing and Payment Companion Guide

8.2 Documentation Requirements ----- 44

Chapter 9 Companion Guide Acknowledgments----- 45

9.1 Clean Bill Acknowledgment Flow and Timing Diagrams ----- 45

9.1.2 Process Steps ----- 47

9.2 Clean Bill-Missing Claim Number Pre-Adjudication Hold (Pending) Status ----- 48

9.2.1 Missing Claim Number- ASC X12N/005010X214 Health Care Claim Acknowledgment (277) ----- 51

9.3 Clean Bill-Missing Report Pre - Adjudication Hold (Pending) Status ----- 52

9.3.1 Missing Report - ASC X12N/005010X214 Health Care Claim Acknowledgment (277)----- 54

9.4 Transmission Responses----- 54

9.4.1 ASC X12N TA1 - Interchange Acknowledgment ----- 54

9.4.2 ASC X12C/005010X231- Implementation Acknowledgement for Health Care Insurance (999)----- 55

9.4.3 ASC X12N/005010X214 Health Care Claim Acknowledgement (277)----- 55

9.4.4 ASC X12N/005010X221 Health Care Claim Payment/Advice (835) ----- 56

Appendix A – Glossary of Terms ----- 57

Appendix B – Code Set References----- 60

Appendix C – Jurisdictional Report Type Codes and DWC Descriptions ----- 65

Appendix D – Security Rule ----- 67

SECURITY RULE TO PROTECT THE CONFIDENTIALITY OF MEDICAL INFORMATION SUBMITTED ELECTRONICALLY----- 67

1.0 Introduction ----- 67

2.0 § 164.302 Applicability. ----- 67

3.0 § 164.304 Definitions. ----- 67

4.0 § 164.306 Security standards: General rules. ----- 68

5.0 § 164.308 Administrative safeguards. ----- 69

6.0 § 164.310 Physical safeguards. ----- 71

7.0 § 164.312 Technical safeguards. ----- 72

8.0 § 164.314 Organizational requirements. ----- 73

9.0 § 164.316 Policies and procedures and documentation requirements.----- 74

Attachment A to Security Rule ----- 75

1.0 Security Standards: Matrix----- 75

California Electronic Medical Billing and Payment Companion Guide

Table of Contents

Chapter 1 Introduction and Overview	6
1.1 HIPAA	6
1.2 California Labor Code § 4603.4	6
Chapter 2 California Workers' Compensation Requirements	7
2.1 Compliance	7
2.1.2 Agents	7
2.1.3 Confidentiality of Medical Information Submitted on Electronic Claims/ Security	7
2.2 National Standard Formats	7
2.2.1 California Prescribed Formats	8
2.2.2 Summary of Adopted Formats and Correlation to Paper Form	9
2.2.3 Optional Formats	10
2.4 Companion Guide Usage	10
2.5 Description of ASC X12 Transaction Identification Numbers	10
2.5.1 Sender/Receiver Trading Partner Identification	10
2.5.2 Claims Administrator Identification	11
2.5.3 Health Care Provider Identification	11
2.5.4 Injured Employee Identification (Member ID Number)	11
2.5.5 Claim Identification	11
2.5.6 Bill Identification	11
2.5.7 Document/ Attachment Identification	12
2.6 Claims Administrator Validation Edits	13
2.7 Description of Formatting Requirements	13
2.7.1 Hierarchical Structure	13
2.8 Description of Transmission/Transaction Dates	13
2.9 Description of Code Sets	13
2.10 Participant Roles	14
2.10.1 Trading Partner	14
2.10.2 Sender	14
2.10.3 Receiver	14
2.10.4 Employer	14
2.10.5 Subscriber	14
2.10.6 Insured	15
2.10.7 Injured Employee	15
2.10.8 Patient	15
2.11 Health Care Provider Agent/Claims Administrator Agent Roles	15
2.12 Duplicate, Appeal/Reconsideration and Corrected Bill Resubmissions	15
2.12.1 Claim Resubmission Code – ASC X12N 837 Billing Formats	15
2.12.3 Corrected Bill Transactions	16
2.12.4 Appeal/Reconsideration Bill Transactions	17
2.13 Balance Forward Billing	19
2.14 California Specific Requirements that Relate to Multiple Electronic Formats	19
2.14.1 Claim Filing Indicator	19
2.14.2 Transaction Set Purpose Code	19
2.14.3 Transaction Type Code	19
2.14.4 FEIN/NPI	19
2.14.5 NCPDP Telecommunication Standard 5.1 Pharmacy Format and NCPDP Batch Standard 1.1	19
2.14.6 Jurisdictional State Code: Compliance State Identification	19
Chapter 3 Companion Guide 837 Professional	21

California Electronic Medical Billing and Payment Companion Guide

<i>3.1 Reference Information</i>	<i>21</i>
<i>3.2 Trading Partner Agreements</i>	<i>21</i>
<i>3.3 Workers' Compensation Health Care Claim: Professional ASC X12N 837 Instructions</i>	<i>21</i>
3.3.1 Health Care Claim: Professional ASC X12N 837 Version 004010X98A1	21
Chapter 4 Companion Guide 837 Institutional	24
<i>4.1 Reference Information</i>	<i>24</i>
<i>4.2 Trading Partner Agreements</i>	<i>24</i>
<i>4.3 Workers' Compensation Health Care Claim: Institutional ASC X12N 837 Instructions</i>	<i>24</i>
4.3.1 Health Care Claim: Institutional ASC X12N 837 Version 00410X096A1	24
Chapter 5 Companion Guide 837 Dental	26
<i>5.1 Reference Information</i>	<i>26</i>
<i>5.2 Trading Partner Agreements</i>	<i>26</i>
<i>5.3 Workers Compensation Health Care Claim: Dental ASC X12N 837 Instructions</i>	<i>26</i>
5.3.1 Health Care Claim: Dental ASC X12N 837 (004010X097A1)	26
Chapter 6 Companion Guide Pharmacy NCPDP 5.1	29
<i>6.1 NCPDP Reference</i>	<i>29</i>
<i>6.2 Trading Partner Agreements</i>	<i>29</i>
<i>6.3 Pharmacy Invoice Number</i>	<i>29</i>
<i>6.4 Billing Date</i>	<i>29</i>
<i>6.5 Dispensing Pharmacy Billing and Pharmacy Billing Agents</i>	<i>29</i>
<i>6.6 Fill Number v. Number of Fills Remaining</i>	<i>30</i>
<i>6.7 Compound Medications</i>	<i>30</i>
<i>6.8 Brand v. Generic</i>	<i>30</i>
<i>6.9 Prescribing Physician</i>	<i>30</i>
<i>6.10 California Pharmacy Workers' Compensation Instructions</i>	<i>30</i>
6.10.1 NCPDP 5.1	30
<i>6.11 Optional Transaction Set Based on ASC X12N 837 004010A1 Implementation Guide.</i>	<i>31</i>
Chapter 7 Companion Guide 835 Payment & Remittance Advice	32
<i>7.1 Reference Information</i>	<i>32</i>
<i>7.2 Trading Partner Agreements</i>	<i>32</i>
<i>7.3 Claim Adjustment Group Code</i>	<i>32</i>
<i>7.4 Claim Adjustment Reason Code</i>	<i>33</i>
<i>7.5 Remittance Advice Remark Codes</i>	<i>33</i>
<i>7.6 California Jurisdictional EOR Statement ID Qualifier</i>	<i>33</i>
<i>7.7 Product/Service ID Qualifier</i>	<i>33</i>
<i>7.8 California 835 Workers' Compensation Instructions</i>	<i>34</i>
7.8.1 ASC X12N 835 004010A1 Healthcare Claim Payment and Remittance Advice	34
Chapter 8 Companion Guide 275 Additional Information to Support a Health Care Claim or Encounter (Documentation/Medical Attachment)	35
<i>8.1 Reference Information</i>	<i>35</i>

California Electronic Medical Billing and Payment Companion Guide

8.2 Documentation Requirements	35
Chapter 9 Companion Guide Acknowledgements	36
9.1 Clean Bill Acknowledgement Flow and Timing Diagrams	36
9.1.2 Process Steps	37
9.2 Clean Bill Missing Claim Number Pre Adjudication Hold (Pending) Status	38
9.2.1 Missing Claim Number 277 Health Care Claim Acknowledgement Process Steps	40
9.3 Clean Bill Missing Report Pre Adjudication Hold (Pending) Status	41
9.3.1 Missing Report ASC X12N 277 Health Care Claim Acknowledgement Process Steps	42
9.4 Transmission Responses	42
9.4.1 ASC X12N TA1 Interchange Acknowledgement	42
9.4.2 ASC X12N 997 Functional Acknowledgement	42
9.4.3 ASC X12N 277 Health Care Claim Acknowledgement	43
9.4.4 ASC X12N 835 Remittance Advice	44
Appendix A Glossary of Terms	45
Appendix B Code Set References	48
Appendix C Jurisdictional Report Type Codes and DWC Descriptions	53
Appendix D Security Rule	55
SECURITY RULE TO PROTECT THE CONFIDENTIALITY OF MEDICAL INFORMATION SUBMITTED ELECTRONICALLY	55
1.0 Introduction	55
2.0 § 164.302 Applicability.	55
3.0 § 164.304 Definitions.	55
4.0 § 164.306 Security standards: General rules.	56
5.0 § 164.308 Administrative safeguards.	57
6.0 § 164.310 Physical safeguards.	59
7.0 § 164.312 Technical safeguards.	60
8.0 § 164.314 Organizational requirements.	61
9.0 § 164.316 Policies and procedures and documentation requirements.	62
Attachment A to Security Rule	63
1.0 Security Standards: Matrix	63
Appendix E Electronic and Digital Signature	65
Statute and Secretary of State Rules	65
1.0 California Government Code	65
1.1 Section § 16.5. Digital signatures	65
2.0 California Code of Regulations, Title 2	65
2.1 Section § 22000. Definitions.	65
2.2 Section § 22002. Criteria for State to Determine if a Digital Signature Technology Is Acceptable for Use by Public Entities.	66
2.3 Section § 22003. List of Acceptable Technologies.	66
2.4 Section § 22004. Provisions for Adding New Technologies to the List of Acceptable Technologies.	70

Chapter 1 Introduction and Overview

1.1 HIPAA

The Administrative Simplification Act provisions of the Federal Health Insurance Portability and Accountability Act of 1996 (HIPAA, Title II) include requirements that national standards for electronic health care transactions and national identifiers for Health Care Providers (Provider), Health Plans, and Employers be established by the Secretary of the Department of Health and Human Services. These standards were adopted to improve the efficiency and effectiveness of the nation's health care system by encouraging the widespread use of electronic data interchange in health care. HIPAA does not apply to workers' compensation matters because the federal statute exempts workers' compensation from its coverage. However, the California Legislature has directed workers' compensation electronic billing standards be consistent with HIPAA where feasible. Additional information regarding the formats adopted under HIPAA is included in Chapter 2.

1.2 California Labor Code § 4603.4

California Labor Code § 4603.4 mandates that California employers accept electronic bills for medical goods and services. Electronic billing is optional for medical providers and health facilities. The statute provides that the regulations which establish electronic billing rules be consistent with HIPAA to the extent feasible. The health care provider, health care facility, or ~~third party biller~~ billing agent/assignee shall use the HIPAA adopted ASC X12N 837 Professional, Institutional or Dental transaction formats to submit medical bill transactions or the NCPDP Telecommunication ~~5.1 D.0~~ and NCPDP Batch Standard ~~4.1 1.2~~ to submit pharmacy bill transactions to the appropriate claims administrator associated with the employer of the injured employee to whom the services are provided.

In workers' compensation, the payor is the Claims Administrator providing coverage for the employer of the injured employee to whom the services are provided. The Claims Administrator, or its authorized agent, is to validate the Electronic Data Interchange (EDI) file according to the guidelines provided in the prescribed national standard format implementation guide, this companion guide, and the jurisdiction data requirements. Problems associated with the processing of the EDI file are to be reported using acknowledgment transactions specified in this companion guide. The Claims Administrator will use the HIPAA adopted ~~ASC X12N 835-005010X221~~ Remittance Advice to report an explanation of payments, reductions, and denial to the health care provider, health care facility, or ~~third party biller~~ billing agent/assignee.

Health care providers, health care facilities, or ~~third party biller~~ billing agent/assignees, claims administrators, clearinghouses, or other electronic data submission entities shall use this guideline in conjunction with HIPAA adopted ASC X12N ~~national implementation guides~~ Type 3 Technical Reports (TR3s), the NCPDP Telecommunication ~~5.1 D.0~~, the NCPDP Batch Standard ~~4.1 1.2~~ and other specified national implementation guides. The ASC X12N ~~implementation guides~~ TR3s can be accessed by contacting the Washington Publishing Company at <http://www.wpc-edi.com>. The NCPDP Telecommunication ~~5.1 D.0~~ and Batch Standard ~~4.1 1.2~~ are available from NCPDP at www.ncdp.org.

This guide supplements the national standard implementation guides and specifies clarifications where necessary to adapt the national standards for use in the California workers' compensation system. Wherever there is a difference between the national standard and this guide, the rules from this guide prevail.

When coordination of a solution is required, the California Division of Workers' Compensation works with (IAIABC) EDI Medical Committee and Provider to Payer Subcommittee to coordinate with national standard setting organizations and committees to address workers' compensation needs.

Chapter 2 California Workers' Compensation Requirements

2.1 Compliance

California Labor Code § 4603.4 (a) (2) requires claims administrators to accept electronic submission of medical bills. Claims administrators must be able to accept electronic medical bills and adhere to the requirements of this guide by XXXX, ~~2011~~ 2012 [~~approximately~~ 18 months after adoption ~~to be inserted by OAL~~]. The entity submitting the bill has the option of submitting bills on paper or electronically.

If an entity chooses to submit bills electronically it must be able to receive an electronic response from the claims administrator. This includes electronic acknowledgements and electronic remittance advice (Explanation of Review).

Electronic billing rules allow for providers and claims administrators to utilize agents to accomplish the requirement of electronic billing, but these rules do not mandate the method of connectivity; the use of, or connectivity to, clearinghouses or similar types of vendors.

Nothing in this document prevents the parties from utilizing Electronic Funds Transfer (EFT) to facilitate payment of electronically submitted bills. Use of EFT is optional, but encouraged by the Division. EFT is not a pre-condition for electronic billing.

Health care providers, health care facilities, ~~third-party biller~~ billing agent/assignees choosing to engage in electronic billing and claims administrators must be able to exchange electronic medical bills in the prescribed standard formats and may exchange data in non-prescribed formats by mutual agreement. All data elements required in the prescribed formats must be present in a mutually agreed upon format.

2.1.2 Agents

Electronic billing rules allow for use of agents to accomplish the requirements of electronic billing.

Entities using agents are responsible for the acts or omissions of those agents executed in the performance of services for the entity.

2.1.3 Confidentiality of Medical Information Submitted on Electronic Claims/ Security

Health care providers, health care facilities, ~~third-party biller~~ billing agent/assignees, and claims administrators, and their agents must comply with rules related to security of confidential medical data. Refer to the Appendix E, Security Rule, regarding specific security requirements for electronically maintained or transmitted confidential health information. The Security Rules in Appendix ~~E~~ D parallel the HIPAA security rules and are modified only to conform to the workers' compensation environment.

2. 2 National Standard Formats

The national standard formats for billing and remittance adopted by the federal Department of Health and Human Services HIPAA rules are contained in 45 CFR Part 162. The formats adopted under California Labor Code § 4603.4 that are aligned with the current federal HIPAA implementation include:

- ~~Health Care Claim: Professional ASC X12N 837 (004010X098A1)~~ ASC X12N/005010X222 Health Care Claim: Professional (837);

California Electronic Medical Billing and Payment Companion Guide

- ~~Health Care Claim: Institutional ASC X12N 837 (004010X096A1)~~ ASC X12N/005010X223 Institutional (837);
- ~~Health Care Claim: Dental ASC X12N 837 (004010X097A1)~~ ASC X12N/005010X224 Dental (837);
- ~~Health Care Claim Payment/Advice ASC X12N 835 (004010X091A1)~~ ASC X12N/005010X221 Payment/Advice (835);
- NCPDP Telecommunication Standard Implementation Guide ~~5-1D.0~~; and
- NCPDP Batch Standard Implementation Guide ~~1-1.2~~

~~The TA 1 Acknowledgment and the 997 Functional Acknowledgment are contained within the ASC X12N 835 (004010X091A1) implementation guide adopted in the HIPAA rules. The ASC X12N TA1 is used to communicate the syntactical analysis of the interchange header and trailer. The ASC X12 997 Functional Acknowledgment, version 4010, is used to communicate acceptance or rejection of a transmission (file).~~

Other national standards formats adopted pursuant to California Labor Code § 4603.4 or suggested for optional use, which are not HIPAA standards but are based on national ASCX12 standards, include:

- TA1 Acknowledgment (used to communicate the syntactical analysis of the interchange header and trailer)
- ASC X12C/005010X231 Implementation Acknowledgment (999) (used to communicate acceptance or rejection of a functional group within an interchange)
- ~~Health Care Claim Acknowledgement ASC X12N 277~~ ASC X12/005010X214 Health Care Claim Acknowledgment (277) (used to communicate acceptance or rejection of a bill transaction, and to communicate that the bill has been put into pending status)
- ~~Health Care Claim Request for Additional Information ASC X12N (277)~~ ASC X12N/005010X213 Health Care Claim Request for Additional Information (277) (may be used to request additional attachments that were not originally submitted with the electronic medical bill and that are needed to process the payment)
- ~~Additional Information to Support a Health Care Claim or Encounter, ASC X12N 275 version 4050~~ ASC X12N/005010X210 Additional Information to Support a Health Care Claim or Encounter (275) (may be used to transmit electronic documentation associated with an electronic medical bill; may accompany the original electronic medical bill, or be in response to a 277/005010X213 Request for Additional Information)

The NCPDP Telecommunication Standard Version ~~5-1D.0~~ and the NCPDP Batch Standard Implementation Guide ~~1-1.2~~ contain the corresponding acknowledgement and error messages to be used for NCPDP transactions.

2.2.1 California Prescribed and Optional Formats

For electronic transactions on or after XXXX, ~~2011~~ 2012 [18 months after effective date of regulation], the Division incorporates by reference and adopts the electronic standard formats and related implementation guides set forth below, as the mandatory transaction standards for electronic billing, acknowledgment, remittance and documentation, except that standards identified as optional are recommended rather than mandatory.

The Division has adopted HIPAA – compliant standards wherever feasible.

(1) Billing:

California Electronic Medical Billing and Payment Companion Guide

~~(a) Dental Billing: The ASC X12N 837 – Health Care Claim: Dental, Version 4010, May 2000, Washington Publishing Company, 004010X097 and Addenda to Health Care Claim: Dental, Version 4010, October 2002, Washington Publishing Company, 004010X097A1.~~

~~(ba) Professional Billing: The ASC X12N 837 – Health Care Claim: Professional, Volumes 1 and 2, Version 4010, May 2000, Washington Publishing Company, 004010X098 and Addenda to Health Care Claim: Professional, Volumes 1 and 2, Version 4010, October 2002, Washington Publishing Company, 004010X098A1.~~

ASC X12N/005010X222

Based on Version 5, Release 1

ASC X12 Standards for Electronic Data Interchange

Technical Report Type 3

Health Care Claim: Professional (837)

MAY 2006

ASC X12N/005010X222E1

Based on Version 5, Release 1

ASC X12 Standards for Electronic Data Interchange

Technical Report Type 3

Health Care Claim: Professional (837)

JANUARY 2009

~~(eb) Institutional/Hospital Billing: The ASC X12N 837 – Health Care Claim: Institutional, Volumes 1 and 2, Version 4010, May 2000, Washington Publishing Company, 004010X096 and Addenda to Health Care Claim: Institutional, Volumes 1 and 2, Version 4010, October 2002, Washington Publishing Company 5, 004010X096A1.~~

ASC X12N/005010X223

Based on Version 5, Release 1

ASC X12 Standards for Electronic Data Interchange

Technical Report Type 3

Health Care Claim: Institutional (837)

MAY 2006

ASC X12N/005010X223A1

Based on Version 5, Release 1

ASC X12 Standards for Electronic Data Interchange

Technical Report Type 3

Health Care Claim: Institutional (837)

Errata Type 1

OCTOBER 2007

ASC X12N/005010X223E1

Based on Version 5, Release 1

ASC X12 Standards for Electronic Data Interchange

Technical Report Type 3

Health Care Claim: Institutional (837)

Errata

JANUARY 2009

(c) Dental Billing:

California Electronic Medical Billing and Payment Companion Guide

ASC X12N/005010X224

Based on Version 5, Release 1

ASC X12 Standards for Electronic Data Interchange

Technical Report Type 3

Health Care Claim: Dental (837)

MAY 2006

ASC X12N/005010X224A1

Version 5, Release 1

ASC X12 Standards for Electronic Data Interchange

Technical Report Type 3

Health Care Claim: Dental (837)

Errata Type 1

OCTOBER 2007

ASC X12N/005010X224E1

Version 5, Release 1

ASC X12 Standards for Electronic Data Interchange

Technical Report Type 3

Health Care Claim: Dental (837)

Errata

JANUARY 2009

(d) Retail Pharmacy Billing:

(i) The Telecommunication Standard Implementation Guide Version 5D, Release 1.0 (Version 5.1D.0), September 1999, National Council for Prescription Drug Programs.

(ii) The Batch Standard Implementation Guide, Version 1, Release 2+ (Version 1.1.2), January 2000, supporting Telecommunication Standard Implementation Guide, Version 5D, Release 0+ (Version 5.1D.0) for the NCPDP Data Record in the Detail Data Record, National Council for Prescription Drug Programs.

(2) **Acknowledgment:**

(a) Electronic responses to ASC X12N 837 transactions:

(i) The TA1 Interchange Acknowledgment contained in the adopted ~~ASC X12N 837 standards~~ .
005010X231

~~(ii) The 997 Functional Acknowledgment contained in the adopted ASC X12N 837 standards.~~

(ii) ASC X12C/005010X231

Based on Version 5, Release 1

ASC X12 Standards for Electronic Data Interchange

Technical Report Type 3

Implementation Acknowledgement for Health Care Insurance (999)

June 2007

(iii) ASC X12N/5010X214

Based on Version 5, Release 1

ASC X12 Standards for Electronic Data Interchange

Technical Report Type 3

Health Care Claim Acknowledgment (277)

JANUARY 2007

(b) Electronic responses to NCPDP Pharmacy transactions:

California Electronic Medical Billing and Payment Companion Guide

The Responses contained in the adopted NCPDP Telecommunication Standard Implementation Guide Version 5.1D.0 and the Batch Standard Implementation Guide, Version 1, Release 1.2 (Version 1.1.2), January 2000.

~~(c) The ASC X12N 277: Health Care Claim Acknowledgement Version 4040, February 2004, Washington Publishing Company, 004040X167.~~

(3) Remittance:

~~The ASC X12N 835 Health Care Claim Payment/Advice, Version 4010, May 2000, Washington Publishing Company, 004010X091, and Addenda to Health Care Claim Payment/Advice, Version 4010, October 2002, Washington Publishing Company, 004010X091A1.~~

ASC X12N/005010X221

Based on Version 5, Release 1

ASC X12 Standards for Electronic Data Interchange

Technical Report Type 3

Health Care Claim Payment/Advice (835)

APRIL 2006

ASC X12N/005010X221E1

JANUARY 2009

(4) Documentation / Attachments to Support a Claim:

~~(a) The ASC X12N 275 Additional Information to Support a Health Care Claim or Encounter, Version 4050, June 2004, Washington Publishing Company, 004050X151. [Optional.]~~

(a) Additional Information to Support a Health Care Claim [Optional]

ASC X12N/005010X210

Based on Version 5, Release 1

ASC X12 Standards for Electronic Data Interchange

Technical Report Type 3

Additional Information to Support a Health Care Claim (275)

February 2008

~~(b) The ASC X12N 277 Health Care Claim Request for Additional Information, Version 4050 June 2004, Washington Publishing Company, 004050X150 [Optional.]~~

(b) Request for Additional Information [Optional]:

ASC X12N/005010X213

Based on Version 5, Release 1

ASC X12 Standards for Electronic Data Interchange

Technical Report Type 3

Health Care Claim Request for Additional Information (277)

July 2007

2.2.2 Source of Prescribed Formats

All transaction standards / implementation guides (except NCPDP retail pharmacy) can be purchased from:

Washington Publishing Company
10940 NE 33rd Place, Suite 204
Bellevue, WA 98004
(425) 562-2245 - Voice
(775) 239-2061 – Fax

Or on the Internet at <http://www.wpc-edi.com/>

NCPDP Telecommunication Standard Implementation Guide and Batch Standard Implementation Guide can be purchased from:

National Council for Prescription Drug Programs, Inc. (NCPDP) ~~at~~ www.ncdp.org
9240 E. Raintree Dr.
Scottsdale, Arizona 85260-7518
(480) 477-1000
(480) 767-1042 - Fax

Or on the Internet at www.ncdp.org

2.2.23 Summary of Adopted Formats and Correlation to Paper Form

Format	Corresponding Paper Form	Function
837P <u>004010X098A1005010X222</u>	CMS-1500	Professional Billing
837I <u>004010X096A1005010X223</u>	UB-04	Institutional/Hospital Billing
837D <u>004010X97A1005010X224</u>	ADA-2006	Dental Billing
NCPDP 54D.0 NCPDP Batch 441.2	NCPDP UCF None	Pharmacy Billing Pharmacy Billing
835 <u>004010X091A1005010X221</u>	None	Explanation of Review (EOR)
TA1 004010	None	Interchange Acknowledgement
997 <u>004010005010X231</u>	None	Transmission Level <u>Implementation</u> Acknowledgment for Health Care Insurance
277 <u>004040X167005010X214</u>	None	Health Care Claim Bill Acknowledgment

2.2.34 Optional Formats

Other formats identified as optional are used in ancillary processes related to electronic billing and reimbursement. The use of these formats is voluntary and the companion guide is presented as a tool to facilitate their use in workers' compensation.

Format	Corresponding Process	Function
275 <u>005010X210</u>	Documentation/Attachments	<u>Submit documentation to support bill</u> Documentation/Attachments

California Electronic Medical Billing and Payment Companion Guide

277-004050X150 <u>005010X213</u>	Documentation/Attachments	Request for Additional Information
--	---------------------------	------------------------------------

2.43 Companion Guide Usage

California workers' compensation implementation of the national standard formats aligns with HIPAA usage and requirements in most circumstances. This Companion Guide is intended to convey information that is within the framework of the *ASC X12N ~~Implementation Guides~~ Technical Reports Type 3 (TR3s)* and *NCPDP Telecommunication Standard Version 5.1D.0 Implementation Guide* and *NCPDP Batch Standard ~~1.1.2~~* adopted for use. The Companion Guide supplements the implementation guides by providing additional instruction on situational implementation factors that are different in workers' compensation than the HIPAA implementation.

When the workers' compensation application situation needs additional clarification or a specific code value is expected, the Companion Guide includes this information in a table format. Shaded rows represent "segments" in the *ASC X12N ~~Implementation Guide~~ TR3*. Non-shaded rows represent "data elements" in the *ASC X12N ~~Implementation Guide~~ TR3*. An example is provided in the following table:

Loop	Segment or Element	Value	Description	California Workers' Compensation Instructions
2000B	SBR		Subscriber Information	In Workers' Compensation, the Subscriber is the Employer
	SBR04		Group or Plan Name	Required when the Employer Department Name/Division is applicable and is different than the Employer reported in Loop 2010BA NM103.
	SBR09	WC	Claim Filing Indicator Code	Value must be 'WC' to indicate Workers' Compensation bill.

Detailed information explaining the various components of the use of loops, segments, data elements, and conditions can be found in the appropriate *ASC X12N ~~Implementation Guide~~ TR3*.

The *ASC X12N ~~Implementation Guides~~ TR3s* also include elements that do not relate directly to workers' compensation processes, for example, coordination of benefits. If necessary, the identification of these loops, segments and data elements can be described in the trading partner agreements to help ensure efficient processing of standard transaction sets.

2.54 Description of ASC X12 Transaction Identification Numbers

The ASC X12 Transaction Identification requirements are defined in the appropriate *ASC X12N ~~Implementation Guide~~ TR3s*, available through the Washington Publishing Company at <http://www.wpc-ed.com>. The Division provides the following additional information regarding transaction identification number requirements:

2.54.1. Sender/Receiver Trading Partner Identification

Workers' compensation standards require the use of the Federal Employer Identification Number (FEIN) or other mutually agreed upon identification numbers to identify Trading Partners (sender/receiver) in electronic billing and reimbursement transmissions. Trading Partners will exchange the appropriate and necessary identification numbers to be reported in Loops 1000A and 1000B (Sender and Receiver).

2.54.2 Claims Administrator Identification

Claims Administrators, and their agents, are also identified through the use of the FEIN or other mutually agreed upon identification number. Claims administrator information is available through direct contact with the claims administrator. For ~~ASC X12N 837~~ 005010X222 and 005010X224 Professional and Dental

California Electronic Medical Billing and Payment Companion Guide

transactions, the Claim Administrator Identification information is populated in Loop 2010BB and in the ~~837 Institutional, 005010X223~~ Loop 2010BC (Payor Information).

Health care providers will need to obtain payor identification information from their connectivity trading partner agent (i.e. clearinghouses, practice management system, billing agent and or other third party vendor) if they are not directly connecting to a claims administrator.

2.54.3 Health Care Provider Identification

Health Care Providers and Health Care Facilities are required to use the National Provider Identification number (NPI). If the provider or facility does not have an NPI, then the provider or facility must use his/her/its state license number.

2.54.4 Injured Employee Identification (Member ID Number)

The injured employee is identified by Social Security Number, date of birth, date of injury and workers' compensation claim number (see below). Social Security Number (SSN) fields are required in electronic billing and reimbursement formats. When a SSN is not available, the health care provider, health care facility, or ~~third party biller~~ billing agent/assignee must report a default 9- digit code of 999999999 in the SSN data element.

The Social Security Identification Number is populated in NM109 segment of Loop 2010BA.

2.54.5 Claim Identification

The workers' compensation claim number assigned by the claim administrator is the claim identification number. This claim identification number is reported in the REF segment of Loop 2010CA, Property and Casualty Claim Number.

The California companion guide instructions for the claim identification REF02 segment of Loop 2010CA differ from the ~~ASC X12N 837 Implementation Guide 005010X222, 005010X223, or 005010X224 (837) TR3s.~~

The California Instructions for the claim identification REF02 segment requires the health care provider, health care facility, or ~~third party biller~~ billing agent/assignee to submit the claim identification number, if known. ~~If the claim identification number is not known, then the required value must be "Unknown" and be reported in the REF02 segment.~~

2.54.6 Bill Identification

The ~~ASC X12N Implementation Guide TR3s~~ refer to a bill as a "claim" for electronic billing transactions. This companion guide refers to these transactions as "bill" in order to avoid confusion, because in workers' compensation, the term "claim" is generally used to refer to a unique injured employee and injury.

The health care provider, health care facility, or ~~third party biller~~ billing agent/assignee, assigns a unique identification number to the electronic bill transaction. For ~~ASC X12N 837~~ 005010X222, 005010X223, or 005010X224 transactions, the bill transaction identification number is populated in Loop 2300 Claim Information CLM Health Claim Segment CLM01 Claim (Bill) Submitter's Identifier data element. This standard HIPAA implementation allows for a patient account number but strongly recommends that submitters use completely unique number for this data element on each individual bill.

2.54.7 Document / Attachment Identification

The ~~ASC X12N 275 Additional Information to Support a Health Care Claim or Encounter~~ ASC X12/005010X210 is the standard electronic format for submitting electronic documentation and is addressed in a later chapter of this companion guide.

California Electronic Medical Billing and Payment Companion Guide

~~Documentation, or the attachment, is identified in the ASC X12N 837 005010X222, 005010X223, or 005010X224 (837) format in PWK Claim Supplemental Information (Attachment) Segment in Loop 2300. The PWK Claim Supplemental Information (Attachment) Segment indicates that an attachment is expected, the type of attachment, delivery method (i.e. electronic, email or fax) and an attachment control number. It is the combination of these attachment identification data elements that will allow a claims administrator to appropriately match the incoming attachment to the electronic medical bill.~~

Bills containing services that require supporting documentation as defined by the Division in the Medical Billing and Payment Guide Section One – 3.0 must be properly annotated in the PWK Attachment Segment. Bill transactions that include services that require documentation and are submitted without the PWK annotation documentation will be rejected.

Documentation related to electronic medical bills may be submitted by facsimile (Fax), encrypted electronic mail (encrypted email) or by electronic transmission using the prescribed format or a mutually agreed upon format. Documentation related to the electronic bill must be submitted within five (5) days of submission of the electronic medical bill and must identify the following elements:

- Patient Name (Injured Employee);
- Claims Administrator Name;
- Date of Service;
- Date of Injury;
- Social Security Number (if available);
- Claim Number (if available);
- Unique Attachment Indicator Number

The PWK Segment and the associated documentation identify the type of documentation through use of ASC X12N standard Report Type Codes. The PWK Segment and the associated documentation also identify the method of submission of the documentation through the use of ASC X12N Report Transmission Codes.

A unique Attachment Indicator Number shall be assigned to all documentation. The Attachment Indicator Number populated on the document shall include Report Type Code, the Report Transmission Code, Attachment Control Qualifier (AC) and the Attachment Control Number. For example, operative note (report type code OB) sent by fax is identified as OBFXAC12345. It is the combination of these data elements that will allow an insurance carrier to appropriately match the incoming attachment to the electronic medical bill.

~~It is recognized that the code sets currently available for version 4010A1 do not include some of the workers' compensation specific codes to identify the type of medical report. The ASC X12N 5010 Standard Report Type Codes do include specific workers' compensation report type codes. In an effort to enhance the communication between the health care provider and claims administrator, the use of specific ASC X12N 5010 Report Type Codes, defined as Jurisdictional Report Type Codes may be used in this implementation.~~

In these situations, when the documentation represents a Jurisdictional Report, the provider should then use the code value of "OZ" (Support Data for Claim) as the Report Type Code in the PWK01 segment and enter in the PWK06 segment the Jurisdictional Report Type Code (e.g. J1=Doctor First Report) in front of the Attachment Control Number. Example: OZFXACJ199923.

California Electronic Medical Billing and Payment Companion Guide

Please refer to Appendix C for a list of Jurisdictional Report Type Codes and associated DWC report type code descriptions.

2.65 Claims Administrator Validation Edits

Claims Administrators may apply validation edits based on California DWC Workers' Compensation Billing and Payment Guide rules, ~~ASC X12N Implementation Guide TR3~~ requirements, and, to the extent that they have been adopted by the DWC for workers' compensation, Medicare policies or rules. Claims administrators may not apply Medicare policies or rules that have not been adopted by the DWC.

Claims Administrators use the ~~ASC X12N 277~~ 005010X214 Health Care Claim Acknowledgement, referred to in this companion guide to communicate acceptance or rejection of a bill transaction. The 005010X214 277 details what errors are present, and if necessary, what action the submitter should take. 005010X214 ~~ASC X12N 277~~ Error rejection codes are used to indicate the reason for the transaction rejection.

2.76 Description of Formatting Requirements

The ASC X12 Formatting requirements are defined in the ~~ASC X12N Implementation Guides TR3s~~, Appendices A.1, available through the Washington Publishing Company at <http://www.wpc-edi.com>. The Division has provided additional information regarding the 005010X222 or 005010X223 or 005010X224 ~~ASC X12N 837~~ Hierarchical structure for workers' compensation billing.

2.76.1 Hierarchical Structure

~~For California workers' compensation, it is assumed that these formats are used to communicate information at the transaction level, with the exception of the ASC X12 997 Acknowledgment. To that end, the parent/child hierarchical structure requires each transaction to contain the necessary hierarchical levels, parent/child qualifiers, and parent/child relationships.~~

~~Each transmission must contain at least one Billing Provider loop containing at least one Subscriber child loop, where the Subscriber is the Workers' Compensation Employer. Each Subscriber loop must contain at least one Patient child loop, where the Patient is the Workers' Compensation Injured Employee.~~

~~Beneath the hierarchical levels, the same logic applies to Injured Employees, bills, and service lines. Each Injured Employee record must contain at least one bill transaction; each bill transaction must contain at least one service line. The maximum number of bills and lines is determined by format standard.~~

For ~~more~~ information on how the ~~HL~~ ASC X12 Hierarchical Structure works refer to Section 2.3.2.1 HL Segment of the ~~ASC X12N Implementation Guides TR3s~~ available through the Washington Publishing Company at <http://www.wpc-edi.com>.

2.87 Description of Transmission/Transaction Dates

The ASC X12 required Transmission/Transaction Dates are defined in the ~~ASC X12N Implementation Guides TR3s~~ available through the Washington Publishing Company at <http://www.wpc-edi.com>.

2.98 Description of Code Sets

Code sets utilized in electronic billing and reimbursement and other ancillary processes are prescribed by the applicable workers' compensation medical fee schedule, ~~ASC X12N Implementation Guides TR3s~~, NCPDP Implementation Guide, Division rule, this companion guide and the California Division of Workers' Compensation Medical Billing and Payment Guide. The code sets are maintained by multiple standard setting organizations.

California Electronic Medical Billing and Payment Companion Guide

Participants are required to utilize current, valid codes based on the date the service or process occurred (i.e. medical service, payment/denial processing, etc).

Information regarding Code Sets (Internal Transaction Codes and External Codes) utilized in ASC X12N electronic transactions are available through the Washington Publishing Company at <http://www.wpc-edi.com>.

ANSI Claims Adjustment Reason Codes (CARC) and the ANSI Remittance Advice Remark Codes (RARC) that have been adopted for use in workers' compensation can be found in the California Division of Workers' Compensation Medical Billing and Payment Guide, Appendix B.

There is currently no dental fee schedule. Dental Codes have been adopted by incorporation by reference of *Current Dental Terminology, Fourth Edition* (CDT-4) of the American Dental Association into the California Division of Workers' Compensation Medical Billing and Payment Guide.

Also refer to Appendix B Code Set Matrix in this companion guide for a comprehensive list of code set references.

2.109 Participant Roles

Roles in the HIPAA implementation guides are generally the same in workers' compensation. The Employer, Insured, Injured Employee and Patient are the roles that are used differently in workers' compensation and are addressed later in this section.

2.109.1 Trading Partner

Trading Partners are entities that have established EDI relationships and exchange information electronically in standard or mutually agreed upon formats. Trading Partners are both Senders and Receivers depending on the electronic process (i.e. Billing v. Acknowledgment).

2.109.2 Sender

A Sender is the entity submitting a transmission to the receiver, or the Trading Partner. The health care provider, health care facility, or ~~third party biller~~ billing agent/assignee, is the Sender in the ~~ASC X12N 837005010X222 or 005010X223 or 005010X224~~ electronic billing process. The Claims Administrator, or its agent, is the Sender in the ~~ASC X12 997005010X231 or ASC X12N 277005010X214~~ Health Care Claim Acknowledgement or ~~ASC X12N 835005010X221~~ remittance processes.

2.109.3 Receiver

A Receiver is the entity that accepts a transmission submitted by a Sender. The health care provider, health care facility, or ~~third party biller~~ billing agent/assignee, is the Receiver in the ~~ASC X12 997005010X231 or ASC X12N 277005010X214~~ Health Care Claim Acknowledgement or ~~ASC X12N 835005010X221~~ remittance processes. The Claims Administrator, or its agent, is the Receiver in the ~~ASC X12N 837005010X222 or 005010X223 or 005010X224~~ electronic billing processes.

2.109.4 Employer

The Employer, as the policyholder of the workers' compensation coverage, is the Subscriber in the workers' compensation implementation of the HIPAA electronic billing and reimbursement formats.

2.109.5 Subscriber

The subscriber or insured is the individual or entity that purchases or is covered by a policy. In this implementation, the workers' compensation policy is obtained by the Employer, who is considered the Subscriber.

2.109.6 Insured

The insured or subscriber is the individual or entity that purchases or is covered by a policy. In group health, the insured may be the patient, or the spouse or parent of the patient. In this implementation, the Employer is considered the Insured entity.

2.109.7 Injured Employee

The Injured Employee is the person who has been injured on the job or has a work related illness and is always considered to be the patient. In group health, there are many relationships a patient may have to the insured. For example, the patient may be the insured, or may be the child or spouse of the insured.

2.109.8 Patient

The patient is the person receiving medical services and is considered the Injured Employee in the workers' compensation implementation of electronic billing and reimbursement processes.

2.110 Health Care Provider Agent/Claims Administrator Agent Roles

Providers, facilities and claims administrators may utilize agents to comply with the electronic billing requirements. Billing agents, electronic billing agents, third party administrators, bill review companies, software vendors, data collection agents, and clearinghouses are examples of companies that may have a role in electronic billing. Entities or persons using agents are responsible for the acts or omissions of those agents executed in the performance of services for the entity or person.

The electronic billing rules require that the claims administrators have the ability to exchange medical billing and reimbursement information electronically with health care providers. The rules do not mandate the use of, or regulate the costs of, agents performing electronic billing functions. Providers and claim administrators are not required by rule to establish connectivity with a clearinghouse or to utilize a specific media/method of connectivity [i.e. Secured File Transfer Protocol (SFTP)].

Use of non-standard formats by mutual agreement between the health care provider, health care facility, or ~~third party biller~~ billing agent/assignee and the claims administrator is permissible.

The electronic billing rules do not regulate the formats utilized between providers and their agents, or claims administrators and their agents, or the method of connectivity between those parties.

2.121 Duplicate, Appeal/Reconsideration and Corrected Bill Resubmissions

2.121.1 Claim Resubmission Code - ~~ASC X12N-837~~ 005010X222, 005010X223, or 005010X224 Billing Formats

Health care providers will use the Claim Frequency Type Code of 7 (Resubmission/Replacement) to identify resubmissions of prior medical bills (not including duplicate original submissions). (The NUBC Instruction for the use of Claim Frequency Type Codes can be referenced on the NUBC website at http://www.nubc.org/FL4forWeb2_RO.pdf) The value is populated in Loop 2300 Claim Information CLM Health Claim Segment CLM05-3 Claim Frequency Type Code of ~~ASC X12-837~~ 005010X222, 005010X223, or 005010X224 billing formats. The health care provider must also populate the Document Control Number/Internal Control Number assigned to the bill by the insurance carrier for the bill being replaced, when the payor has provided this number in response to the previous bill submission. This information is populated in Loop 2300 Claim Information REF Original Reference Number (ICN/DCN) of ~~ASC X12N-837~~ 005010X222, 005010X223, or 005010X224 billing formats.

California Electronic Medical Billing and Payment Companion Guide

Health care providers must also populate the appropriate NUBC Condition Code to identify the type of resubmission on electronically submitted medical bills. The Condition Code is submitted based on the instructions for each bill type, in the Institutional (HI Segment), Professional (~~K3~~ HI Segment) or Dental (~~NTE~~ K3 Segment). Condition codes provide additional information to the claims administrator when the resubmitted bill is a request for reconsideration.

2.121.2 Duplicate Bill Transaction Prior To Payment

A Condition Code "W2" (Duplicate of the original bill) is required when submitting a bill that is a duplicate. The Condition Code is submitted based on the instructions for each bill type, in the Institutional (HI Segment), Professional (~~K3~~ HI Segment) or Dental (~~NTE~~ K3 Segment). The duplicate bill must be identical to the original bill, with the exception of the added Condition Code. No new dates of service or itemized services may be included.

Duplicate Bill Transaction
<ul style="list-style-type: none">• CLM05-3 = Identical value as original. Cannot be "7";• Condition codes in HI/K3/NTE are populated with a condition code qualifier 'BG' and code value:W2=Duplicate• Example: K3*BGW2• Original Reference Number does not apply• The resubmitted bill must be identical to the original bill, except for the W2 condition code. No new dates of service or itemized services may be included

Duplicate bill transactions shall be submitted no earlier than fifteen (15) working days after the Claims Administrator has acknowledged receipt of a complete electronic bill transaction and prior to receipt of an ASC X12N 835 Healthcare Claim Remittance Advice transaction.

The Claims Administrator may reject a bill transaction with a Condition Code W2 indicator if (1) the duplicate bill is received within fifteen (15) working days after transmission of the ~~997 acknowledgment~~ 005010X231, (2) the bill has been processed and ~~an a~~ ASC X12N 835 005010X221 transaction has been generated, or (3) the Claims Administrator does not have a corresponding accepted original transaction with the same bill identification numbers. The duplicate bill transaction may be denied through the use of ~~an a~~ 005010X221 ASC X12N 835 Healthcare Care Claim Remittance Payment/Advice transaction.

2.121.3 Corrected Bill Transactions

A replacement bill is sent when an element of data on the bill was either not previously sent or needs to be corrected.

~~The replacement bill should be identical to the original except for the corrections. Its identifying information should be changed to reflect its status as a corrected bill. The provider must populate the Original Document Control Number/Internal Control Number assigned to the bill by the claims administrator when the payor has provided this number in response to the previous bill submission. This information is populated in Loop 2300 Claim Information REF*F8 Segment: Original Reference Number (ICN/DCN) of ASC X12N 837 billing formats.~~

When identifying elements change, the "correction" is accomplished by a "void" and re-submission process: A bill with CLM05-3 = 8 (Void) must be submitted to cancel the incorrect bill, followed by the submission of a new original bill with the correct information.

California Electronic Medical Billing and Payment Companion Guide

Replacement or void of prior bill should not be done until the prior submitted bill has reached final adjudication status. Final adjudication can be determined from remittance advice, web application or when showing a finalized code under Claim Status Category 277 or non electronic means.

Corrected Bill Transaction
<ul style="list-style-type: none"> • CLM05-3 = 7 indicates a Replacement Bill • Condition codes of W2 to W5 in HI/K3/NTE are not used; • REF*F8 includes the claims administrator's Original Reference Number, if assigned by the payor. • A corrected bill shall include the original dates of service and the same itemized services rendered as the original bill. • When identifying elements change, the "correction" is accomplished by a "void" and re-submission process • A bill with CLM05-3 = 8 (Void) must be submitted to cancel the incorrect bill, followed by the submission of a new <u>original</u> bill with the correct information.

The Claims Administrator may reject a revised bill transaction if (1) the Claims Administrator does not have a corresponding adjudicated bill transaction with the same bill identification number or (2) inadequate documentation supporting the request for correction. The revised bill transaction may be denied through the use of ~~ena ASC X12N 835~~005010X221 Healthcare Claim Remittance Advice transaction.

2.1.4 Appeal/Reconsideration Bill Transactions

Electronic submission of Reconsideration transactions is accomplished in the ~~ASC X12N 837~~005010X222, 005010X223, or 005010X224 billing format through the use of Claim Frequency Type Code 7 in Loop 2300 Claim Information CLM Health Claim Segment CLM05-3 Claim Frequency Type Code. The value '7' Replacement of a Prior Claim represents Resubmission transactions.

The Reconsideration Claim Frequency Type Code '7' is used in conjunction with the Original Internal Control Number/Document Control Number assigned to the bill by the claim administrator when the payor has provided this number in response to the previous bill submission. This information is populated in Loop 2300 Claim Information REF Original Reference Number (ICN/DCN) of ~~ASC X12N 837~~005010X222 or 005010X223 or 005010X224 billing formats.

The health care provider must also populate the appropriate condition code to identify the type of resubmission on electronically submitted medical bills. The NUBC Condition codes which apply to reconsiderations and appeals include:

- W3 – 1st Level Appeal is a request for reconsideration or appeal with the claim administrator.
- W4 – 2nd Level Appeal is resubmitted after receipt of a jurisdiction decision/order, typically from Medical Fee Dispute resolution.
- W5 – 3rd Level Appeal is resubmitted after receipt of a hearing or other judicial decision and order.

These codes are included in the 2300/K3 segment on professional claims, 2300/HI segment on institutional claims, and 2300/NTE segment on dental claims.

Reconsideration bill transactions may only be submitted after receipt of ~~ena ASC X12N 835~~005010X221 payment/advice transaction for the corresponding accepted original bill. The same bill identification number is used on both the original and the Reconsideration bill transaction to associate the transactions. All elements, fields, and values in the Reconsideration bill transaction, except the Reconsideration specific

California Electronic Medical Billing and Payment Companion Guide

qualifiers and PWK Attachment Segment, must be the same as the original bill transaction. Subsequent Reconsideration bill transactions related to the same original bill transaction may be submitted after receipt of ~~an ASC X12N 835 a 005010X221~~ transaction corresponding to the initial Reconsideration bill transaction. Subsequent Reconsideration bill transactions shall not be submitted prior to the claims administrator taking final action on the original reconsideration request.

Corresponding documentation related to appeals/reconsideration is required in accordance with the California rules for initial bill submission. The PWK Segment (Claim Supplemental Information) is required to be properly annotated when submitting an attachment related to an appeal/reconsideration.

The ASC X12 ~~Implementation Guides TR3s~~ and the California Division of Workers' Compensation indicate that the value passed in CLM01 represents a unique identification number specific to the bill transaction, the Provider Unique Bill Identification Number. The California Division of Workers' Compensation implementation links the original bill (parent) to the subsequent bill transaction through the use of the Provider Unique Bill Identification Number (CLM01). The intent is to link an appeal, or multiple subsequent appeals, to a single original parent bill transaction.

The ASC X12 ~~Implementation Guides TR3s~~ includes a REF Reference Identification Number Segment in Loop 2300 Claim Information that represents an Original Reference Number (ICN/DCN), which is the claims administrator generated unique transaction identification number. This number needs to be included on resubmitted bills to ensure that the payor can match the resubmission request with its original processing action.

Appeal/ Reconsideration Bill Transaction
<ul style="list-style-type: none">• CLM05-3 = 7;• Condition codes in HI/K3/NTE are populated with a condition code qualifier 'BG' and one of the following codes values must be present:<ul style="list-style-type: none">W3 = 1st Level Appeal (Request for reconsideration or appeal with the claim administrator)W4 = 2nd Level Appeal (Resubmitted after receipt of a judicial decision and order, typically from Medical Fee Dispute resolution)W5 = 3rd Level Appeal (Resubmitted after receipt of a hearing or other judicial decision and order)• REF*F8 includes the claim administrators Original Reference Number, if assigned by the payor.• The appeal/reconsideration bill must be identical to the original bill, with the exception of the added Condition Code, Original Reference Identifier Number (ICN/DCN) and the Claim Frequency Type Code. No new dates of service or itemized services may be included.• Supporting Documentation is required.• Loop 2300, PWK Segment must be properly annotated.

The Claims Administrator may reject an appeal/reconsideration bill transaction if (1) the bill information does not match the corresponding original bill transaction, (2) the Claims Administrator does not have a corresponding accepted original transaction, (3) the original bill transaction has not been completed (no corresponding ~~ASC X12N 835 005010X221~~ payment/advice transaction or the ~~Remittance~~ payment/advice submission has been sent.), (4) the bill is submitted without the PWK annotation. Corresponding documentation related to appeals/reconsideration is required in accordance with the Division's rules for initial bill submission.

The Claims Administrator may deny appeal/reconsideration bill transactions for missing documentation. The bill transaction may be denied through the use of ~~an ASC X12N 835 a 005010X221 Healthcare~~ Care Claim ~~Remittance~~ Payment/Advice transaction.

2.132 Balance Forward Billing

Balance forward billing is not permissible. Balance forward bills are bills that include a balance carried over from a previous bill along with additional services.

2.143 California-Specific Requirements that Relate to Multiple Electronic Formats

The requirements in this section identify California workers' compensation specific requirements that apply to more than one electronic format. Requirements that are related to a specific format are identified in the chapter related to that format.

The directions for the elements identified below apply to multiple or all ASC X12N electronic file formats.

2.143.1 Claim Filing Indicator

The ~~ASC X12N 837~~ 005010X222, 005010X223, or 005010X224 Claim Filing Indicator code for workers compensation is 'WC' populated in Loop 2000B Subscriber Information, SBR Subscriber Information Segment field SBR09.

2.143.2 Transaction Set Purpose Code

The Transaction Set Purpose Code in the Transaction Set Header BHT Beginning of Hierarchical Transaction Segment field BHT02 in ~~ASC X12 837~~ 005010X222, 005010X223, or 005010X224 formats is designated as '00' Original. Insurance Carriers are required to acknowledge acceptance or rejection of transmissions (files) and transactions (bills). Transmissions that are rejected by the insurance carrier are corrected by the provider and are submitted, after correction, as '00' Original transmissions.

2.143.3 Transaction Type Code

The Transaction Type Code in the Transaction Set Header BHT Beginning of Hierarchical Transaction Segment field BHT06 in 005010X222, 005010X223, or 005010X224 formats is designated as 'CH' Chargeable. Currently, there is not a requirement for health care providers to report electronic medical billing data to the Division. Therefore, code 'RP' (Reporting) is not appropriate for this implementation.

2.14.4 FEIN/NPI

~~The FEIN is populated in the NM1 Individual or Organizational Name Segment, field NM109, with the appropriate qualifier in field NM108 when required. When the entity is a health care provider, the NPI is populated in the NM1 Segment and the FEIN is populated in the associate REF Reference Identification Segment with the appropriate qualifier.~~

2.143.5-4 NCPDP Telecommunication Standard 5.1D.0 Pharmacy Format and NCPDP Batch Standard 4.11.2

Issues related to electronic pharmacy billing transactions are addressed in Chapter 6 Companion Guide Pharmacy.

2.143.6-5 Jurisdictional State Code: Compliance State Identification

Anyone exchanging transactions that apply to the California Workers' Compensation State of Jurisdiction must be submitted using the California companion guides, regardless of where the submitter, receiver, provider, or payor are located.

A Jurisdiction State Code (two byte postal state abbreviation) is required for California workers' compensation medical bills when the state of jurisdiction is different than the Billing Provider or Service Facility address state

California Electronic Medical Billing and Payment Companion Guide

code. The Jurisdictional State Code assists the receiver, in identifying which jurisdictional specific edits should be applied to a workers' compensation bill.

The ~~837~~ 005010X222 or 005010X223 Professional and Institutional Jurisdictional State Code is populated in Loop 2300, K301 and 005010X224 in the Dental NTE Segment. The Jurisdiction State Qualifier is 'LU' followed by the state jurisdiction code (CA= California). Example: California Jurisdictional State Code = LUCA

Chapter 3 ~~Companion Guide 837 Professional ASC~~ X12N/005010X222 Health Care Claim: Professional (837)

The information contained in this companion guide has been created for use in conjunction with the ~~ASC X12N 837 004010A1 Professional Healthcare Claim Implementation Guide~~ X12N/005010X222 Health Care Claim: Professional (837). It should not be considered a replacement for the ~~ASC X12N 837 004010A1 Professional Healthcare Claim Implementation Guide~~ 005010X222, but rather used as a supplement to the ASC X12N implementation guide TR3 where specialized workers' compensation direction is needed. Wherever the national standard differs from the California rules, the California rules prevail.

3.1 Reference Information

The implementation guide for the ~~ASC X12N 837 004010A1 Health Care Claim: Professional~~ 005010X222 is available through the Washington Publishing Company at <http://www.wpc-edi.com>.

3.2 Trading Partner Agreements

This companion guide is not intended to replace the components of trading partner agreements that define additional transaction parameters beyond the ones described.

Trading Partners may utilize non-prescribed electronic formats by mutual agreement. The data elements transmitted pursuant to such a Trading Partner Agreement must, at a minimum, contain all the same required data elements found within the ASC X12N ~~Implementation Guide~~ TR3s and the California companion guide.

3.3 Workers' Compensation ~~Health Care Claim: Professional ASC~~* *X12N 837 Instructions for ASC X12N/005010X222 Health Care Claim:* ***Professional (837)**

Instructions for California specific requirements are also provided in Chapter 2 California Workers' Compensation Requirements. The following table identifies the application/instructions for California workers' compensation that are different than the HIPAA implementation:

~~3.3.1 Health Care Claim: Professional ASC X12N 837 Version 004010X98A1~~

Loop	Segment or Element	Value	Description	California Workers' Compensation Instructions
1000A	PER		Submitter Contact Information	
1000A	PER03	TE	Communication Number Qualifier	One occurrence of PER Segment must have a value 'TE' Telephone Number.
1000A	PER04		Communication Number	One value must be the Telephone Number of the submitter.
2000B	HL		Subscriber Hierarchical Level	In Workers' Compensation, the Subscriber is the Employer
2000B	SBR		Subscriber Information	In Workers' Compensation, the Subscriber is the Employer
2000B	SBR04	-	Group or Plan Name	Required when the Employer Department Name/Division is applicable and is different than the Employer reported in Loop 2010BA, Segment NM102.
2000B	SBR09	WC	Claim Filing Indicator Code	Value must be 'WC' for Workers' Compensation.
2010BA			Subscriber Name	In Workers' Compensation, the Subscriber is the Employer. (i.e., an organization, sole proprietor or company name).
2010BA	NM102	2	Entity Type Qualifier	Value must be '2' non person.

California Electronic Medical Billing and Payment Companion Guide

Loop	Segment or Element	Value	Description	California Workers' Compensation Instructions
2010BA	NM103		Last or Organization Name	Value must be the name of the Employer
2010BA	NM108	MI	Identification Code Qualifier	Value must be 'MI' Member Identification Number
2010BA	NM109		Primary Identifier	Member Identification Number. Enter the patient's Social Security Number. If the patient does not have a Social Security Number then enter the following 9 digit number: '99999999'
2010BA	N3		Subscriber Address	Enter Employer Address
2010BA	N4		Subscriber City/State/ Zip Code	Enter Employer City/ State/Zip Code
2000G	PAT01	20	Patient's Relationship to Subscriber	Value must be '20' Employee
2010CA	REF		Property & Casualty Claim Number	Workers' compensation claim number assigned by the claims administrator. This Segment is Required for California Workers' Compensation.
2010CA	REF02		Workers' Compensation Claim Number	Enter the claim number if known. If not known, then enter the default value 'UNKNOWN'
2300	CLM11		Related Cause Codes	If more than one code applies to the bill, one of the occurrences in CLM11 must have a value of 'EM' for Employment Related.
2300	DTP		Onset of Current Symptom or Illness date	Required when the condition reported is for an occupational illness.
2300	DTP		Accident Date	Required when the condition reported is for an occupational accident/injury.
2300	DTP		Disability Begin Date	Do not use Segment. Leave Blank
2300	DTP		Disability End Date	Do not use Segment. Leave blank
2300	PWK		Claim Supplemental Information	Required when submitting attachments related to the medical bill.
2300	PWK01	=	Report Type Code	Value must be 'OZ' when report is a Jurisdictional Report. For all other reports use appropriate 004010 Report Type Code.
2300	PWK02	-	Report Transmission Code	Use the Report Transmission Code 'EL' for file transfers. For all other report transmission's use appropriate 004010 Report Transmission Codes with the exception of the 'BM' By Mail Code which is not allowed under the California Rules.
2300	PWK06	-	Attachment Control Number	In formatting the attachment control number, always include the Jurisdictional Report Type Code as the first two characters of the attachment control number. Example: J1-Doctor's First Report of Injury: J12456789
2300	K3		File Information	Resubmission Condition Code is required for submitting a bill that is a duplicate or an appeal/reconsideration. Jurisdiction State Code Qualifier is required for California workers' compensation medical bills, when the Billing Provider or Service Facility State Code is different than the Jurisdiction State Code (compliance state).
2300	K301		State Data Requirement	Resubmission Condition Code Enter the Condition Code Qualifier 'BG' followed by the appropriate resubmission code. 'W2' Duplicate of Original 'W3' 1st Level appeal (request for reconsideration or appeal with claims administrator) 'W4' 2nd Level appeal (resubmitted after receipt of judicial decision) 'W5' 3rd Level appeal (resubmitted after receipt of hearing or judicial decision)

California Electronic Medical Billing and Payment Companion Guide

Loop	Segment or Element	Value	Description	California Workers' Compensation Instructions
				<p>Example: BCW3</p> <p>Note: Do not use condition codes when submitting revised or corrected bill.</p> <p>Jurisdiction State Code Qualifier Enter the Jurisdiction State Code Qualifier 'LU' followed by the state jurisdiction code 'CA' to indicate that California is the Jurisdictional State. Example: LUCA</p>
2300	NTE		Claim Note	When applicable, identify any additional information that needs to be conveyed in the Claim Note Segment. For example, a comment may require additional information to assist in the proper adjudication of the workers' compensation medical bill that is not identified elsewhere within the transaction data set.
2310B			Rendering Provider	Required when loop 2310B is used
2310B	PRV	ZZ	Provider Specialty Code	The Rendering Provider Specialty Information is required for California workers' compensation medical bills.
2410			Drug Identification	Only one repeat of this loop is permitted for workers' compensation medical bills
2420A			Rendering Line Provider	Required when loop 2420A is used.
2420A	PRV	ZZ	Provider Specialty Code	The Rendering Provider Specialty Information is required for California workers' compensation medical bills.

3.3.1 ASC X12N/005010X222 Health Care Claim: Professional (837)

Loop	Segment or Element	Value	Description	California Workers' Compensation Instructions
<u>1000A</u>	<u>PER</u>		<u>Submitter Contact Information</u>	<u>One occurrence of the Communication Number Qualifier must be 'TE' – Telephone Number.</u>
<u>2000B</u>	<u>SBR</u>		<u>Subscriber Information</u>	<u>In Workers' Compensation, the Subscriber is the Employer.</u>
<u>2000B</u>	<u>SBR04</u>		<u>Group or Plan Name</u>	<u>Required when the Employer Department Name/Division is applicable and is different than the Employer reported in Loop 2010BA, Segment NM103.</u>
<u>2000B</u>	<u>SBR09</u>	<u>WC</u>	<u>Claim Filing Indicator Code</u>	<u>Value must be 'WC' for Workers' Compensation.</u>
<u>2010BA</u>			<u>Subscriber Name</u>	<u>In Workers' Compensation, the Subscriber is the Employer (e.g. an organization, sole proprietor or company name.)</u>
<u>2010BA</u>	<u>NM102</u>	<u>2</u>	<u>Entity Type Qualifier</u>	<u>Value must be '2' non-person.</u>
<u>2010BA</u>	<u>NM103</u>		<u>Last Or Organization Name</u>	<u>Value must be the name of the Employer.</u>
<u>2010BA</u>	<u>N3</u>		<u>Subscriber Address</u>	<u>Enter employer address</u>

California Electronic Medical Billing and Payment Companion Guide

<u>Loop</u>	<u>Segment or Element</u>	<u>Value</u>	<u>Description</u>	<u>California Workers' Compensation Instructions</u>
2010BA	N4		Subscriber City/State/Zip Code	Enter employer city/state/zip code
2000C	PAT01	20	INDIVIDUAL RELATIONSHIP CODE	Value must be '20' Employee.
2010CA	REF		Property And Casualty Claim Number	Workers' compensation claim number assigned by the claims administrator. This Segment is Required for California Workers' Compensation. For a first bill submitted by a provider, a bill missing a claim number shall be placed in pending status for up to 5 days to attach claim number.
2010CA	REF01		Reference Identification Qualifier	Value must be 'Y4'.
2010CA	REF02		Workers' Compensation Claim Number	Enter the claim number if known. If not known, then enter the default value ' UNKNOWN'.
2010CA	REF		Property and Casualty Patient Identifier	The patient's Social Security number is required.
2010CA	REF01		Reference Identification Qualifier	Value must be 'SY'.
2010CA	REF02		Reference Identification	Enter the patient's Social Security Number. If the patient does not have a Social Security Number then enter the following 9-digit number '999999999'
2300	CLM11		Related Cause Codes	If more than one code applies to the bill, one of the occurrences in CLM11 must have a value of 'EM' -- Employment Related.
2300	DTP		Accident Date	Required when the condition reported is for an occupational accident/injury. For Specific Injury: Enter the date of incident or exposure. For Cumulative Injury or Occupational Disease: Enter either: 1) the last date of occupational exposure to the hazards of the occupational disease or cumulative injury or 2) the date that the employee first suffered disability from cumulative injury or occupational disease and knew (or should have known) that the disability was caused by the employment.
2300	DTP		Disability Dates	Do not use Segment. Leave blank.
2300	PWK		Claim Supplemental Information	Required when submitting attachments related to the medical bill.
2300	PWK01		Report Type Code	Value must be 'OZ' when report is a Jurisdictional Report. For all other reports, use appropriate 005010 Report Type Code.
2300	PWK02		Report Transmission Code	Use the Report Transmission Code 'EL' for file transfers. For all other report transmissions use appropriate 005010 Report Transmission Codes with the exception of the 'BM' – By Mail Code which is not allowed under the California rules.
2300	PWK06		Attachment Control Number	In formatting the attachment control number, always include the Jurisdictional Report Type Code as the first two characters of the attachment control number. Example: Report Type J1=Doctor's First Report of Injury: Jurisdiction Report: PWK*OZ*BM***AC*J1DMN0012~ Standard Report: PWK*OB*BM***AC*DMN0012~

California Electronic Medical Billing and Payment Companion Guide

<u>Loop</u>	<u>Segment or Element</u>	<u>Value</u>	<u>Description</u>	<u>California Workers' Compensation Instructions</u>
<u>2300</u>	<u>K3</u>		<u>File Information</u>	<u>Jurisdiction State Code Qualifier is required for California workers' compensation medical bills, when the Billing Provider or Service Facility State Code is different than the Jurisdiction State Code (compliance state).</u>
<u>2300</u>	<u>K301</u>		<u>State Data Requirement Fixed Format Information</u>	<u>Jurisdiction State Code (State of Compliance Code) Required when the provider knows the state of jurisdiction is different than the billing provider's state (2010AA/N4/N402). Enter the state code qualifier 'LU' followed by the state code 'CA' to indicate that California is the Jurisdiction State. For example, 'LUCA' indicates the medical bill is being submitted under California medical billing requirements.</u>
<u>2300</u>	<u>NTE</u>		<u>Claim Note</u>	<u>When applicable, identify any additional information that needs to be conveyed in the Claim Note Segment. For example, a comment may require additional information to assist in the proper adjudication of the workers' compensation medical bill that is not identified elsewhere within the transaction data set.</u>
<u>2300</u>	<u>HI</u>		<u>Condition Information</u>	<p><u>Required when condition information applies to the medical bill.</u></p> <p><u>Resubmission Condition Code</u> <u>Required when submitting a bill that is a duplicate or an appeal/reconsideration.</u></p> <p><u>Enter the Condition Code Qualifier 'BG' followed by the appropriate resubmission code.</u> <u>W2 - Duplicate of the original bill</u> <u>W3 - Level 1 Appeal</u> <u>W4 - Level 2 Appeal</u> <u>W5 - Level 3 Appeal</u> <u>Example: BGW3</u></p> <p><u>Note: Do not use condition codes when submitting revised or corrected bills.</u></p>
<u>2310B</u>	<u>PRV</u>		<u>Rendering Provider</u>	<u>Required when loop 2310B is used.</u>
<u>2310B</u>	<u>PRV</u>	<u>ZZ</u>	<u>Provider Specialty Code</u>	<u>The Rendering Provider Specialty Information is required for California workers' compensation medical bills.</u>
<u>2410</u>			<u>Drug Identification</u>	<u>Only one repeat of this loop is permitted for workers' compensation medical bills.</u>
<u>2420A</u>			<u>Rendering Line Provider</u>	<u>Required when loop 2420A is used.</u>
<u>2420A</u>	<u>PRV</u>	<u>ZZ</u>	<u>Provider Specialty Code</u>	<u>The Rendering Provider Specialty Information is required for California workers' compensation medical bills.</u>

Chapter 4 Companion Guide 837 Institutional ASC X12N/005010X223 Health Care Claim: Institutional (837)

The information contained in this companion guide has been created for use in conjunction with the ASC X12N 837 004010X096 Institutional Healthcare Claim Implementation Guide ASC X12N/005010X223 Health Care Claim: Institutional (837) TR3. It should not be considered a replacement for the ASC X12N 837 004010X096 Institutional Health Care Claim Implementation Guide 005010X223, but rather used as a supplement to the ASC X12N implementation guide TR3 where specialized workers' compensation direction is needed. Wherever the national standard differs from the California rules, the California rules prevail.

4.1 Reference Information

The implementation guide for the ASC X12N 837 004010X096 Health Care Claim Institutional 005010X223 is available through the Washington Publishing Company at <http://www.wpc-edi.com>.

4.2 Trading Partner Agreements

This companion guide is not intended to replace the components of trading partner agreements that define additional transaction parameters beyond the ones described.

Trading Partners may utilize non-prescribed electronic formats by mutual agreement. The data elements transmitted pursuant to such a Trading Partner Agreement must, at a minimum, contain all the same required data elements found within the ASC X12N Implementation Guides and the California companion guide.

4.3 Workers' Compensation ~~Health Care Claim: Institutional ASC X12N 837~~ Instructions for ASC X12N/005010X223 Health Care Claim: Institutional (837)

Instructions for California specific requirements are also provided in Chapter 2 California Workers' Compensation Requirements. When the application/instructions for California 837 Institutional workers' compensation are different than the HIPAA implementation, it is identified in the following table:

~~4.3.1 Health Care Claim: Institutional ASC X12N 837 Version 00410X096A1~~

Loop	Segment or Element	Value	Description	California Workers' Compensation Instructions
1000A	PER		Submitter Contact Information	
1000A	PER03	TE	Communication Number Qualifier	One occurrence of PER Segment must have a value 'TE' Telephone Number.
1000A	PER04		Communication Number	One value must be the Telephone Number of the submitter.
2000B	HL		Subscriber Hierarchical Level	In Workers' Compensation, the Subscriber is the Employer
2000B	SBR		Subscriber Information	In Workers' Compensation, the Subscriber is the Employer
2000B	SBR04	-	Group or Plan Name	Required when the Employer Department Name/Division is applicable and is different than the Employer reported in Loop 2010BA, Segment NM103.
2000B	SBR09	WC	Claim Filing Indicator Code	Value must be 'WC' - Workers' Compensation.
2010BA	NM1		Subscriber Name	In Workers' Compensation, the Subscriber is the Employer. (i.e., an organization, sole proprietor or company name).
2010BA	NM102	2	Entity Type Qualifier	Value must be '2' non person.

California Electronic Medical Billing and Payment Companion Guide

Loop	Segment or Element	Value	Description	California Workers' Compensation Instructions
2010BA	NM103		Last or Organization Name	Value must be the name of the Employer.
2010BA	NM108	MI	Identification Code Qualifier	Value must be 'MI' Member Identification Number
2010BA	NM109		Primary Identifier	Member Identification Number. Enter the patient's Social Security Number. If the patient does not have a Social Security Number then enter the following 9 digit number: '99999999'.
2010BA	N3		Subscriber Address	Enter Employer Address
2010BA	N4		Subscriber City/State/ Zip Code	Specify City/ State/Zip Code
2000G	PAT01	20	Patient's Relationship to Subscriber	Value must be '20' Employee
2010CA	REF		Property & Casualty Claim Number	Workers' compensation claim number assigned by the insurance carrier. This Segment is Required for workers' compensation medical bills submitted electronically.
2010CA	REF02		Workers' Compensation Claim Number	Enter the claim number if known. If not known, then enter the default value 'UNKNOWN'.
2300	PWK		Claim Supplemental Information	Required when submitting attachments related to the medical bill.
2300	PWK01	-	Report Type Code	Value must be 'OZ' when report is a Jurisdictional Report. For all other reports use appropriate 004010 Report Type Code.
2300	PWK02	-	Report Transmission Code	Use the Report Transmission Code 'EL' for file transfers. For all other report transmission's use appropriate 004010. Report Transmission Codes with the exception of the 'BM' By Mail Code which is not allowed under the California Rules.
2300	PWK06	-	Attachment Control Number	In formatting the attachment control number, always include the Jurisdictional Report Type Code as the first two characters of the attachment control number. Example: J12456789
2300	K3		File Information	Jurisdiction State Code Qualifier is required for California workers' compensation medical bills. , when the Billing Provider or Service Facility State Code is different than the Jurisdiction State Code (compliance state).
2300	K301		State Data Requirement	Jurisdiction State Code Qualifier Enter the Jurisdiction State Code Qualifier 'LU' followed by the state jurisdiction code 'CA' to indicate that California is the Jurisdictional State. Example: LUCA.
2300	NTE		Billing Note	When applicable, identify any additional information that needs to be conveyed in the Billing Note Segment. For example, a comment may require additional information to assist in the proper adjudication of the workers' compensation medical bill that is not identified elsewhere within the transaction data set.
2300	HI01		Occurrence Information	At least one Occurrence Code must be entered with value of '04' Accident/Employment Related or '11' illness. The Occurrence Date must be the Date of Occupational Injury or Illness.
2300	HH		Condition Information	Required when a condition code applies. Required when submitting a bill that is a duplicate or an appeal. W2' Duplicate of Original W3' 1st Level appeal (request for reconsideration or appeal with claims administrator) W4' 2nd Level appeal (resubmitted after receipt of judicial decision)

California Electronic Medical Billing and Payment Companion Guide

Loop	Segment or Element	Value	Description	California Workers' Compensation Instructions
				<p>WS-3rd Level appeal (resubmitted after receipt of hearing or judicial decision)</p> <p>Note: Do not use condition codes when submitting revised or corrected bill</p>

4.3.1 ASC X12N/005010X223 Health Care Claim: Institutional (837)

<u>Loop</u>	<u>Segment</u>	<u>Value</u>	<u>Description</u>	<u>California Workers' Compensation Instructions</u>
1000A	PER		Submitter Contact Information	One occurrence of the Communication Number Qualifier must be 'TE' – Telephone Number.
2000B	SBR		Subscriber Information	In Workers' Compensation, the Subscriber is the Employer.
2000B	SBR04		Group or Plan Name	Required when the Employer Department Name/Division is applicable and is different than the employer reported in Loop 2010BA, Segment NM103.
2000B	SBR09	WC	Claim Filing Indicator Code	Value must be 'WC' - Workers' Compensation.
2010BA	NM1		Subscriber Name	In Workers' Compensation, the Subscriber is the Employer (e.g. an organization, sole proprietor, or company name.)
2010BA	NM102	2	Entity Type Qualifier	Value must be '2' non-person.
2010BA	NM103		Last Or Organization Name	Value must be the name of the Employer.
2010BA	N3		Subscriber Address	Enter Employer address.
2010BA	N4		Subscriber City/State/Zip Code	Enter Employer city/state/zip code.)
2000C	PAT01	20	Patient's Relationship to Subscriber	Value must be '20' – Employee.
2010CA	REF		Property And Casualty Claim Number	Workers' compensation claim number assigned by the claims administrator. This Segment is Required for California Workers' Compensation. For a first bill submitted by a provider, a bill missing a claim number shall be placed in pending status for up to 5 days to attach claim number.
2010CA	REF01		Reference Identification Qualifier	Value must be 'Y4'.
2010CA	REF02		Workers' Compensation Claim Number	Enter the claim number if known. If not known, then enter the default value 'UNKNOWN'.
2010CA	REF		Property And Casualty Patient Identifier	Required to enter the patient's Social Security Number.
2010CA	REF01		Reference Identification Qualifier	Value must be 'SY'.
2010CA	REF02		Reference Identification	Enter the patient's Social Security Number. If the patient does not have a Social Security Number then enter the following 9 digit number: '99999999'.
2300	DTP		Accident Date	Required when the condition reported is for an occupational accident/injury. For Specific Injury: Enter the date of incident or exposure. For Cumulative Injury or Occupational Disease: Enter either: 1) the last date of occupational exposure to the hazards of the occupational disease or cumulative injury or 2) the date that the employee first suffered disability from cumulative injury or occupational disease and knew (or should have known) that the disability was caused by the employment.

California Electronic Medical Billing and Payment Companion Guide

<u>Loop</u>	<u>Segment</u>	<u>Value</u>	<u>Description</u>	<u>California Workers' Compensation Instructions</u>
2300	PWK		<u>Claim Supplemental Information</u>	<u>Required when submitting attachments related to the medical bill.</u>
2300	PWK01		<u>Report Type Code</u>	<u>Value must be 'OZ' when report is a Jurisdictional Report. For all other reports, use appropriate 005010 Report Type Code.</u>
2300	PWK02		<u>Report Transmission Code</u>	<u>Use the Report Transmission Code 'EL' for file transfers For all other report transmission's use appropriate 005010.Report Transmission Codes with the exception of the 'BM' - By Mail Code which is not allowed under the California Rules.</u>
2300	PWK06		<u>Attachment Control Number</u>	<u>In formatting the attachment control number, always include the Jurisdictional Report Type Code as the first two characters of the attachment control number. Example Report Type J1=Doctor's First Report of Injury: Jurisdiction Report: PWK*OZ*BM***AC*J1DMN0012~ Standard Report: PWK*OB*BM***AC*DMN0012~</u>
2300	K3		<u>File Information</u>	<u>Jurisdiction State Code Qualifier is required for California workers' compensation medical bills. , when the Billing Provider or Service Facility State Code is different than the Jurisdiction State Code (compliance state).</u>
2300	K301		<u>State Data Requirement</u>	<u>Jurisdiction State Code Qualifier Enter the Jurisdiction State Code Qualifier 'LU' followed by the state jurisdiction code 'CA' to indicate that California is the Jurisdictional State: Example: LUCA.</u>
2300	NTE		<u>Billing Note</u>	<u>When applicable, identify any additional information that needs to be conveyed in the Billing Note Segment. For example, a comment may require additional information to assist in the proper adjudication of the workers' compensation medical bill that is not identified elsewhere within the transaction data set.</u>
2300	HI01		<u>Occurrence Information</u>	<u>At least one Occurrence Code must be entered with value of '04' - Accident/Employment Related or '11' - illness. The Occurrence Date must be the Date of Occupational Injury or Illness.</u>
2300	HI		<u>Condition Information</u>	<u>Required when Condition Information applies to the medical bill.</u> <u>Resubmission Condition Code:</u> <u>Required when submitting a bill that is a duplicate or an appeal/reconsideration.</u> <u>W2 - Duplicate of the original bill</u> <u>W3 - Level 1 Appeal</u> <u>W4 - Level 2 Appeal</u> <u>W5 - Level 3 Appeal</u> <u>Note: Do not use condition codes when submitting revised or corrected bills.</u>

Chapter 5 Companion Guide ~~837 Dental ASC~~ X12N/005010X224 Health Care Claim: Dental (837)

This companion guide for the ~~ASC X12N 837 004010X097 Dental Health Care Claim ASC~~ X12N/005010X224 Health Care Claim: Dental (837) transaction has been created for use in conjunction with the ~~ASC X12N 837 004010X097 Dental Claim Implementation Guide 005010X224~~. It should not be considered a replacement for the ~~ASC X12N 837 004010X097 Dental Claim Implementation Guide ASC 005010X224 Dental TR3~~, but rather used as a supplement to the ASC X12N ~~implementation guide TR3~~ where specialized workers' compensation direction is needed. ~~Wherever the national standard differs from the California rules, the California rules prevail.~~

5.1 Reference Information

The implementation guide for the ~~ASC X12 837 004010X097 Health Care Claim: Dental ASC~~ X12N/005010X224 Dental is available through the Washington Publishing Company at <http://www.wpc-edi.com>

5.2 Trading Partner Agreements

This companion guide is not intended to replace the components of trading partner agreements that define additional transaction parameters beyond the ones described.

Trading Partners may utilize non-prescribed electronic formats by mutual agreement. The data elements transmitted pursuant to such a Trading Partner Agreement must, at a minimum, contain all the same required data elements found within the ASC X12N Implementation Guides and the California companion guide.

5.3 Workers Compensation Instructions for ~~Health Care Claim: Dental ASC X12N 837~~ ASC X12N/005010X224 Health Care Claim: Dental (837)

Instructions

Instructions for California specific requirements are also provided in Chapter 2 California Workers' Compensation Requirements. When the application/instructions for California 837 Dental workers' compensation are different than the HIPAA implementation, it is identified in the following table:

~~5.3.1 Health Care Claim: Dental ASC X12N 837 (004010X097A1)~~

Loop	Segment or Element	Value	Description	California Workers' Compensation Instructions
1000A	PER		Submitter Contact Information	
1000A	PER03	TE	Communication Number Qualifier	One occurrence of PER Segment must have a value 'TE' Telephone Number.
1000A	PER04		Communication Number	One value must be the Telephone Number of the submitter.
2000B	HL		Subscriber Hierarchical Level	In Workers' Compensation, the Subscriber is the Employer
2000B	SBR		Subscriber Information	In Workers' Compensation, the Subscriber is the Employer
2000B	SBR04	-	Group of Plan Name	Required when the Employer Department Name/Division is applicable and is different than the Employer reported in Loop 2010BA, Segment NM103.

California Electronic Medical Billing and Payment Companion Guide

Loop	Segment or Element	Value	Description	California Workers' Compensation Instructions
2000B	SBR09	WC	Claim Filing Indicator Code	Value must be 'WC' — Workers' Compensation.
2010BA	NM1		Subscriber Name	In Workers' Compensation, the Subscriber is the Employer. (i.e., an organization, sole proprietor or company name).
2010BA	NM102	2	Entity Type Qualifier	Value must be '2' non person.
2010BA	NM103		Last or Organization Name	Value must be the name of the Employer
2010BA	NM108	MI	Identification Code Qualifier	Value must be 'MI' — Member Identification Number
2010BA	NM109		Primary Identifier	Member Identification Number. Enter the patient's Social Security Number. If the patient does not have a Social Security Number then enter the following 9 digit number: '00000000'.
2010BA	N3		Subscriber Address	In Workers' Compensation, the Subscriber Address is the address of the Employer.
2010BA	N4		Subscriber City/State/Zip Code	Enter Employer City/State/Zip Code
2000C	PAT01	20	Patient's Relationship to Subscriber	Value must be '20' — Employee
2010CA	REF02		Workers' Compensation Claim Number	Enter the claim number if known. If not known, then enter the default value of 'UNKNOWN'.
2300	CLM11		Related Cause Code	One of the occurrences in CLM11 must have a value of 'EM' — Employment Related
2300	DTP		Onset of Current Symptom or Illness date	Required when the condition reported is for an occupational illness.
2300	DTP		Accident Date	Required when the condition reported is for an occupational accident/injury.
2300	DTP		Disability Begin Date	Do not use Segment. Leave Blank
2300	DTP		Disability End Date	Do not use Segment. Leave blank
2300	PWK		Claim Supplemental Information	Required when submitting attachments related to the medical bill.
2300	PWK01	-	Report Type Code	Use appropriate code value or 'OZ' when report is a jurisdictional report.
2300	PWK02	-	Report Transmission Code	One of the occurrences in CLM11 must have a value of 'EM' — Employment Related
2300	PWK05	AC	Identification Code Qualifier	Value must be 'AC' Attachment Control Number
2300	PWK06	-	Attachment Control Number	In formatting the attachment control number, always include the Jurisdictional Report Type Code as the first two characters of the attachment control number. Example: J1 — Doctor's First Report of Injury: J13456789
2300	NTE		Remarks	Resubmission Condition Code required for submitting a bill that is a duplicate or an appeal/reconsideration. Jurisdiction State Code Qualifier is required for California workers' compensation medical bills when the Billing Provider or Service Facility State Code is different than the Jurisdiction State Code (compliance state).
2300	NTE01	ADD	Note Reference Code	Value must be 'ADD' — Additional Information
2300	NTE02		Claim Note Text	Resubmission Condition Code — Required when submitting a bill that is a duplicate or an appeal. Enter the Condition Code Qualifier 'BG' followed by the appropriate resubmission code. 'W2' — Duplicate of Original 'W3' — 1st Level appeal (request for reconsideration or appeal with insurance carrier) 'W4' — 2nd Level appeal (resubmitted after receipt of judicial decision) 'W5' — 3rd Level appeal (resubmitted after receipt of

California Electronic Medical Billing and Payment Companion Guide

Loop	Segment or Element	Value	Description	California Workers' Compensation Instructions
				<p>hearing or judicial decision) <i>Example: BCW3</i></p> <p>Note: Do not use condition codes when submitting revised or corrected bill.</p> <p><u>Jurisdiction State Code Qualifier</u> Enter the Jurisdiction State Code Qualifier 'LU' followed by the state jurisdiction code 'CA' to indicate that California is the Jurisdictional State. Example: <u>LUCA</u></p>
2310B			Rendering Provider	Required when loop 2310B is used
2310B	PRV	ZZ	Provider Specialty Code	The Rendering Provider Specialty Information is required for California workers' compensation medical bills.
2420A			Rendering Line Provider	Required when loop 2420A is used.
2420A	PRV	ZZ	Provider Specialty Code	The Rendering Provider Specialty Information is required for California workers' compensation medical bills.

5.3.1 ASC X12N/005010X224 Health Care Claim: Dental (837)

<u>Loop</u>	<u>Segment</u>	<u>Value</u>	<u>Description</u>	<u>California Workers' Compensation Instructions</u>
<u>1000A</u>	<u>PER</u>		<u>Submitter Edi Contact Information</u>	<u>One occurrence of the Communication Number Qualifier must be 'TE' – Telephone Number.</u>
<u>2000B</u>	<u>SBR</u>		<u>Subscriber Information</u>	<u>In Workers' Compensation, the Subscriber is the Employer.</u>
<u>2000B</u>	<u>SBR04</u>		<u>Group or Plan Name</u>	<u>Required when the Employer Department Name/Division is applicable and is different than the Employer reported in Loop 2010BA, Segment NM103.</u>
<u>2000B</u>	<u>SBR09</u>	<u>WC</u>	<u>Claim Filing Indicator Code</u>	<u>Value must be 'WC' for Workers' Compensation.</u>
<u>2010BA</u>	<u>NM1</u>		<u>Subscriber Name</u>	<u>In Workers' Compensation, the Subscriber is the Employer (e.g., an organization, sole proprietor or company name.)</u>
<u>2010BA</u>	<u>NM102</u>	<u>2</u>	<u>Entity Type Qualifier</u>	<u>Value must be '2' non-person.</u>
<u>2010BA</u>	<u>NM103</u>		<u>Last Or Organization Name</u>	<u>Value must be the name of the Employer.</u>
<u>2010BA</u>	<u>N3</u>		<u>Subscriber Address</u>	<u>In Workers' Compensation, the Subscriber Address is the address of the Employer.</u>
<u>2010BA</u>	<u>N4</u>		<u>Subscriber City/State/Zip code</u>	<u>Enter Employer city/state/zip code.</u>
<u>2000C</u>	<u>PAT01</u>	<u>20</u>	<u>Patient's Relationship to Subscriber</u>	<u>Value must be '20' - Employee.</u>
<u>2010CA</u>	<u>REF</u>		<u>Property And Casualty Claim Number</u>	<u>Workers' compensation claim number assigned by the claims administrator. This Segment is Required for California Workers' Compensation. For a first bill submitted by a provider, a bill missing a claim number shall be placed in pending status for up to 5 days to attach claim number.</u>

California Electronic Medical Billing and Payment Companion Guide

<u>Loop</u>	<u>Segment</u>	<u>Value</u>	<u>Description</u>	<u>California Workers' Compensation Instructions</u>
<u>2010CA</u>	<u>REF01</u>		<u>Reference Identification Qualifier</u>	Value must be 'Y4'.
<u>2010CA</u>	<u>REF02</u>		<u>Workers' Compensation Claim Number</u>	Enter the claim number if known. If not known, then enter the default value of 'UNKNOWN'.
<u>2010CA</u>	<u>REF</u>		<u>Property And Casualty Patient Identifier</u>	When applicable, the Jurisdiction Companion Guides may include a usage statement to indicate whether or not the patient identifier must be used. For example, a comment may state: "Required."
<u>2010CA</u>	<u>REF01</u>		<u>Reference Identification Qualifier</u>	Value must be 'SY'.
<u>2010CA</u>	<u>REF02</u>		<u>Reference Identification</u>	Enter the patient's Social Security Number. If the patient does not have a Social Security Number then enter the following 9-digit number: '99999999'.
<u>2300</u>	<u>DTP</u>		<u>Accident date</u>	Required when the condition reported is for an occupational accident/injury. For Specific Injury: Enter the date of incident or exposure. For Cumulative Injury or Occupational Disease: Enter either: 1) the last date of occupational exposure to the hazards of the occupational disease or cumulative injury or 2) the date that the employee first suffered disability from cumulative injury or occupational disease and knew (or should have known) that the disability was caused by the employment.
<u>2300</u>	<u>PWK</u>		<u>Claim Supplemental Information</u>	Required when submitting attachments related to the medical bill.
<u>2300</u>	<u>PWK01</u>		<u>Report Type Code</u>	Value must be 'OZ' when report is a Jurisdictional Report. For all other reports use appropriate 005010 Report Type Code.
<u>2300</u>	<u>PWK02</u>		<u>Report Transmission Code</u>	One of the occurrences in CLM11 must have a value of 'EM' -- Employment Related.
<u>2300</u>	<u>PWK05</u>	<u>AC</u>	<u>Identification Code Qualifier</u>	Value must be 'AC' - Attachment Control Number.
<u>2300</u>	<u>PWK06</u>		<u>Attachment Control Number</u>	In formatting the attachment control number, always include the Jurisdictional Report Type Code as the first two characters of the attachment control number. Example Report Type J1=Doctor's First Report of Injury: Jurisdiction Report: PWK*OZ*BM***AC*J1DMN0012~ Standard Report: PWK*OB*BM***AC*DMN0012~.
<u>2300</u>	<u>NTE</u>		<u>Remarks</u>	Resubmission Condition Code required for submitting a bill that is a duplicate or an appeal/reconsideration. Jurisdiction State Code Qualifier is required for California workers' compensation medical bills when the Billing Provider or Service Facility State Code is different than the Jurisdiction State Code (compliance state).
<u>2300</u>	<u>NTE01</u>	<u>ADD</u>	<u>Note Reference Code</u>	Value must be 'ADD' – Additional Information.
<u>2300</u>	<u>NTE02</u>		<u>Claim Note Text</u>	Resubmission Condition Code – Required when submitting a bill that is a duplicate or an appeal. Enter the Condition Code Qualifier 'BG' followed by

California Electronic Medical Billing and Payment Companion Guide

<u>Loop</u>	<u>Segment</u>	<u>Value</u>	<u>Description</u>	<u>California Workers' Compensation Instructions</u>
				<p>the appropriate resubmission code.</p> <p>'W2' - Duplicate of Original 'W3' - 1st Level appeal (request for reconsideration or appeal with insurance carrier) 'W4' - 2nd Level appeal (resubmitted after receipt of judicial decision) 'W5' - 3rd Level appeal (resubmitted after receipt of hearing or judicial decision) <u>Example: BGW3</u></p> <p>Note: Do not use condition codes when submitting revised or corrected bill.</p> <p>Jurisdiction State Code Qualifier Enter the Jurisdiction State Code Qualifier 'LU' followed by the state jurisdiction code 'CA' to indicate that California is the Jurisdictional State: <u>Example:</u></p>
<u>2310B</u>			<u>Rendering Provider</u>	Required when loop 2310B is used.
<u>2310B</u>	<u>PRV</u>	<u>ZZ</u>	<u>Provider Specialty Code</u>	The Rendering Provider Specialty Information is required for California workers' compensation medical bills.
<u>2420A</u>			<u>Rendering Line Provider</u>	Required when loop 2420A is used.
<u>2420A</u>	<u>PRV</u>	<u>ZZ</u>	<u>Provider Specialty Information</u>	The Rendering Provider Specialty Information is required for California workers' compensation medical bills.

Chapter 6 Companion Guide Pharmacy NCPDP ~~5.1~~D.0

This companion guide has been created for use in conjunction with the *NCPDP Telecommunication Standard Implementation Guide Version ~~5.1~~D.0* and the *NCPDP Batch Standard Implementation Guide Version 1.4 2*. It should not be considered a replacement for the NCPDP guides, but rather used as a supplement to the guides. Wherever the NCPDP national standards differ from the California rules, the California rules prevail. The text below includes cross-references to the data fields of the paper NCPDP Universal Claim Form.

6.1 NCPDP Reference

The NCPDP Telecommunication Standard Implementation Guide Version ~~5.1~~D.0 that supports the electronic pharmacy billing transaction, along with the NCPDP Data Dictionary (September 1999) and the NCPDP Batch Standard Implementation Guide Version 1.4 2 are available through the National Council for Prescription Drug Programs (NCPDP), www.ncdp.org.

6.2 Trading Partner Agreements

This companion guide is not intended to replace the components of trading partner agreements that define additional transaction parameters beyond the ones described. The Division does not mandate a method of connectivity or processing method.

Trading Partners may utilize non-prescribed electronic formats by mutual agreement. The data elements transmitted pursuant to such a Trading Partner Agreement must, at a minimum, contain all the same required data elements found within the *NCPDP Telecommunication Standard Implementation Guide Version ~~5.1~~D.0* and the *NCPDP Batch Standard Implementation Guide Version 1.4 2* and the California companion guide.

6.3 Pharmacy Invoice Number

The Prescription/Service Reference Number (4Ø2-D2) (Field #62 on WC/PC UCF) is the reference number assigned by the provider for the dispensed drug/product and/or service provided and will be used to identify the invoice number for electronic billing. Real time and batch electronic pharmacy bill processing uses the specific prescription number to identify an individual, unique pharmacy transaction. Other fields, such as the Service Provider ID (2Ø1-B1) (Field #32 on WC/PC UCF) can be used for uniqueness.

6.4 Billing Date

For electronically submitted ~~claims~~ pharmacy bills, the date of service is considered the Billing Date, unless other transactional verification information is provided to the claims administrator to confirm the date the bill was transmitted. This date is communicated in the Claim Segment of the NCPDP Telecommunication Standard Implementation Guide Version ~~5.1~~D.0 Date of Service field (4Ø1-D1) (Field #66 on WC/PC UCF), which is included in the Transaction Header Segment.

6.5 Dispensing Pharmacy Billing and Pharmacy Billing Agents

When the dispensing pharmacy is the billing entity, the Federal Employer Identification Number (FEIN) is reported in the Service Provider ID field (2Ø1-B1) at the header level and the NPI Number in the Provider ID field (444-E9) in the Pharmacy Provider Segment.

The current version of the NCPDP Telecommunication Standard Implementation Guide Version ~~5.1~~D.0 does not support the use of third party billing agents or pharmacy benefit managers (PBM) when they are acting as pharmacy billing agents. The format does not currently support a designated field, an identifier, or a qualifier to flag an entity as a pharmacy billing agent.

California Electronic Medical Billing and Payment Companion Guide

When a third party biller or PBM are the billing and payee of the claim(s), the FEIN of the third party biller or PBM will be reported in the Service Provider ID field (201-B1) at the header level and the dispensing pharmacy information will be identified by their NPI number in the Provider ID field (444-E9) in the Pharmacy Provider Segment. It is important that these issues be addressed in the trading partner agreements between the claims administrator, their electronic billing agent, and pharmacy claim submitters.

6.6 Fill Number v. Number of Fills Remaining

The NCPDP Telecommunication Standard Implementation Guide Version ~~5.1~~ D.0 supports the Fill Number (Field 403-D3) (Field #64 on WC/PC UCF) and the Number of Refills Authorized (Field 415-DF), which taken together, provide the number of refills remaining.

6.7 Compound Medications

Division rules require components of compound medications be identified. Compound medications in the NCPDP Telecommunication Standard Implementation Guide Version ~~5.1~~ D.0 are identified through the use of the Compound Code (Field 406-D6) (Fields 89 – 98 on WC/PC UCF) value 2(Compound). If the transaction includes a compound medication, the Compound Segment is required.

6.8 Brand v. Generic

The NCPDP Telecommunication Standard Implementation Guide Version ~~5.1~~ D.0 contains a code set to indicate dispensed as written status, Dispense As Written (DAW)/ Product Selection Code (Field 408-D8) (Field #72 on WC/PC UCF). Some dispensed as written codes do indicate the generic availability status. However, the name of the medication, and the brand/generic status of the NDC code, is not communicated for each medication. Claims Administrators may obtain this information from purchased NDC code sets or from their agents/vendor partners.

6.9 Prescribing Physician

For California workers' compensation claims, the Prescribing Physician Identification Number will be the NPI. This data is supported in the NCPDP Telecommunication Standard Implementation Guide Version ~~5.1~~ D.0 in Fields 411-DB (Prescriber ID) (Field # 40 on WC/PC UCF) and 466-EZ (Field # 41 on WC/PC UCF) (Qualifier (12) DEA Number). If the prescribing physician does not have an NPI, the prescribing physician's state license number should be populated. The NCPDP Telecommunication Standard Version ~~5.1~~ D.0 contains qualifiers for all the identifiers detailed.

6.10 California Pharmacy Workers' Compensation Instructions

With the exception of the specific instructions below, for electronic transactions the *NCPDP Telecommunication Standard Implementation Guide Version ~~5.1~~ D.0* should be used to complete the electronic transaction.

6.10.1 NCPDP Telecommunication Standard Implementation Guide ~~5.1~~ D.0

NCPDP Field Description	NCPDP Paper Field Number	NCPDP Workers' Compensation Requirements	NCPDP 5.1 Data Element	California Workers' Compensation Instructions
Claim Reference Number	Field 17	R	435-DZ	Enter the claim number assigned by the workers' compensation claims administrator, if known. If not known, enter default value "CA00"
Pharmacy ID	Field 32	R	201-B1	Enter the Pharmacy NPI number.
Prescriber ID	Field 40	R	411-DB	Enter Prescribing Doctor NPI. If none available, enter Prescribing Doctor State License number. If none available, enter other value as qualified by

California Electronic Medical Billing and Payment Companion Guide

NCPDP Field Description	NCPDP Paper Field Number	NCPDP Workers' Compensation Requirements	NCPDP 5.1 Data Element	California Workers' Compensation Instructions
				NCPDP Telecommunication Standard Implementation Guide Version 5.1
Prescriber ID Qualifier	Field 41	R	466-EZ	Code qualifying the Prescriber ID (411-DB)
Usual & Customary Charge	Field 99	Q	426-DQ	Optional
Patient Paid Amount	Field 106	S	433-DX	Not applicable for California workers' compensation

California Electronic Medical Billing and Payment Companion Guide

<u>Segment</u>	<u>Field</u>	<u>Description</u>	<u>California Companion Guide Workers' Compensation Comments or Instructions</u>
<u>INSURANCE</u>	<u>302-C2</u>	<u>CARDHOLDER ID</u>	<u>If the Cardholder ID is not available or not applicable, the value must be 'NA'.</u>
<u>CLAIM</u>	<u>415-DF</u>	<u>NUMBER OF REFILLS AUTHORIZED</u>	<u>This data element is required. If no refills authorized, enter '0'</u>
<u>PRICING</u>	<u>426-DQ</u>	<u>USUAL AND CUSTOMARY CHARGE</u>	<u>This data element is required. Enter the pharmacy's usual and customary price, i.e. the amount charged cash customers for the prescription exclusive of dispensing fee, sales tax or other amounts claimed</u>
<u>PHARMACY PROVIDER</u>	<u>465-EY</u>	<u>PROVIDER ID QUALIFIER</u>	<u>This data element is required. The value must be '05' – NPI Number.</u>
<u>PRESCRIBER</u>	<u>466-EZ</u>	<u>PRESCRIBER ID QUALIFIER</u>	<u>This data element is required. The value must be '01' – NPI Number, however, if prescriber NPI is not available, enter applicable prescriber ID qualifier..</u>
<u>WORKERS' COMPENSATION</u>			<u>The Workers' Compensation Segment is required for workers' compensation claims.</u>
<u>WORKERS' COMPENSATION</u>	<u>435-DZ</u>	<u>CLAIM/REFERENCE ID</u>	<u>This data element is required. Enter the claim number assigned by the workers' compensation claims administrator, if known. If claim number is not known, then enter the value of 'Unknown'</u>

~~6.11 Optional Transaction Set Based on ASC X12N 837 004010A1 Implementation Guide.~~

~~The companion guide for the ASC X12N 837 004010A1 Professional is also referred to as the Alternate Pharmacy Billing Format. The use of this optional transaction set requires mutual agreement of the health care provider and the Claims Administrator and is not a substitute for the NCPDP Telecommunication Standard Version 5.1 Implementation Guide. The Claims Administrator, their eBill agents, and pharmacy claim submitters must document any agreement to use this format in their trading partner agreements. Due to the differences between NCPDP 5.1 and ANSI X12 code sets and formats, the parties must understand the programming changes that may be needed to map and process transactions using any mutually agreed upon format.~~

Chapter 7 Companion Guide ~~835 Payment & Remittance Advice~~ ASC X12N/005010X221 Payment/Advice (835)

The ~~ASC X12N 835 004010A1 Health Claim Payment/Advice~~ ASC X12N/005010X221 Payment/Advice (835) is used by the payor to advise the provider of payment remittance and is also used to convey objections to the bill. Labor Code §4603.2 (b)(1)(B) requires the payor to “advise in the manner prescribed by the administrative director”, the physician, or another provider, of the “items being contested, the reasons for contesting these items, and the remedies available to the physician or the other provider if he or she disagrees.” In order to provide detailed information to the provider, the Division directs the claims administrator to use the Explanation of Review (EOR) standards set forth in the Medical Billing and Payment Guide, Appendix B Standard Explanation of Review. For electronic billing purposes, this is accomplished by use of the ~~ASC X12N 835 004010A1 Health Claim Payment/Advice~~ ASC X12N/005010X221 Payment/Advice. The Claim Adjustment Group Codes, the Claim Adjustment Reason Codes and Remittance Advice Remark Codes are the standard code sets required. The Division of Workers’ Compensation has developed jurisdictional DWC Bill Adjustment Reason Codes for use on paper EOR’s which do not have an exact equivalent for use in the ~~ASC X12N 835 Healthcare Claim Payment/Advice~~ 005010X221 format. A crosswalk table has been developed showing the relationship between the DWC Bill Adjustment Reason Codes and the CARC/RARC codes for use in electronic EOR’s. This table is found in the Medical Billing and Payment Guide, Appendix B – 1.0.

This companion guide for the ~~ASC X12N 835 Healthcare Claim Payment/Advice~~ 005010X221 transaction has been created for use in conjunction with the ~~ASC X12N 835 004010A1 Healthcare Claim Payment and Remittance Advice Implementation Guide~~ ASC X12N/005010X221 Payment/Advice TR3. It should not be considered a replacement for the ~~ASC X12N 835 004010A1 Healthcare Claim Payment and Remittance Advice Implementation Guide~~ ASC X12N/005010X221 Payment/Advice TR3, but rather used as a supplement to the ASC X12N implementation guide TR3 where specialized workers’ compensation direction is needed. ~~Wherever the national standard differs from the California rules, the California rules prevail.~~

7.1 Reference Information

The Implementation Guide for the ~~ASC X12N 835 004010A1 Healthcare Claim Payment and Remittance Advice~~ ASC X12N/005010X221 Payment/Advice transaction is available through the Washington Publishing Company at <http://www.wpc-edi.com>.

7.2 Trading Partner Agreements

This companion guide is not intended to replace the components of trading partner agreements that define additional transaction parameters beyond the ones described.

Trading Partners may utilize non-prescribed electronic formats by mutual agreement. The data elements transmitted pursuant to such a Trading Partner Agreement must, at a minimum, contain all the same required data elements found within the ASC X12N Implementation Guides and the California companion guide.

7.3 Claim Adjustment Group Codes

The Division prescribes the use of ANSI Claim Adjustment Group Codes in the ~~ASC X12N 835~~ 005010X221 format. The most current, valid codes should be used as appropriate for workers’ compensation. The ANSI Group Code represents the general category of payment, reduction, or denial.

For example, the ANSI Group Code CO Contractual Obligation might be used in conjunction with an ANSI Reason Code for a network contract reduction.

The ANSI Group Code transmitted in the ~~ASC X12N 835~~ 005010X221 is the same code that is transmitted in the IAIABC 837 Medical State Reporting EDI reporting format for reporting to the Workers' Compensation Information System pursuant to Labor Code section 138.6. The Division accepts ANSI Group Codes that were valid on the date the insurance carrier paid or denied a bill. The Division does not validate for ANSI Group Code/ANSI Reason Code agreement in Medical State Reporting EDI processing.

7.4 Claim Adjustment Reason Codes

The ~~ASC X12N 835~~ 005010X221 uses the ANSI Claim Adjustment Reason Codes, as the electronic means of providing specific payment, reduction, or denial information. The Division prescribes a specific subset of the ANSI Claim Adjustment Reason Codes to be used in the ~~ASC X12N 835~~ 005010X221 format. These codes are set forth in the Medical Billing and Payment Guide, Appendix B – 1.0 California DWC ANSI Matrix Crosswalk. As a result, use of the ~~ASC X12N 835~~ 005010X221 eliminates the use of proprietary reduction codes and free form text.

7.4.1 Claim Adjustment Reason Codes 191, 214, 221, W1

The California Division of Workers' Compensation maintains a web site URL at: http://www.dir.ca.gov/dwc/Laws_Regulations.htm that has links to the text of the statutes and rules used by workers' compensation payers as a basis to reduce or deny a charge. When an entire bill is denied at the Claim level or reduced at the Line level using CARC Codes, 191, 214, 221 or W1, the payor will need to provide the applicable California DWC Statute/Code associated with that CARC code to communicate the basis of the reduction or denial. If one of the CARC codes 191, 214, 221 or W1 is used, then the following California DWC Labor Code reference number is to be reported in the REF02.

CARC 191 Labor Code §3600

CARC 214 Labor Code §3600

CARC 221 Labor Code §5402

CARC W1 Labor Code §5307.1

If an entire bill is denied at the claim level, using one of the above CARC codes, then use the Insurance Policy Number Segment (Loop 2100) Other Claim Related Information REF, with an 'IG' qualifier and report the associated California DWC Statute/Code in REF02.

Example #1:

Claim adjustment reason code 191 is applied when an entire bill is denied on the basis that primary liability for the injury or illness being treated is denied per California DWC Labor Code §3600.

- In REF 01, use qualifier IG
- In REF 02 specify the appropriate code for the applicable statute.
Example : REF*IG*3600~

If a bill is reduced at the line level using one of the above CARC codes, then use the Healthcare Policy Identification Segment (Loop 2110) to specify the appropriate California DWC Statute/Code for the statute supporting the adjustment. The DWC URL http://www.dir.ca.gov/dwc/Laws_Regulations.htm address must be communicated to the provider in loop 1000A segment PER.

Example #2:

Claim adjustment reason code W1 is applied and a line item of a bill is reduced based on the California workers' compensation medical fee schedule rule per California Labor Code §5307.1.

- In REF01, use qualifier OK
- In REF02, specify the appropriate code for the applicable statute
Example: REF*OK*5307.1~
- The California DWC URL http://www.dir.ca.gov/dwc/Laws_Regulations.htm address must be referred to in loop 1000A segment PER.
Example: PER*IC**UR*http://www.dir.ca.gov/dwc/Laws_Regulations.htm

7.5 Remittance Advice Remark Codes

The ~~ASC X12N 835~~ 005010X221 format supports the use of ANSI Remittance Advice Remark Codes to provide supplemental explanation for a payment, reduction or denial already described by an ANSI Claims Adjustment Reason Code. The Division prescribes a specific subset of the ANSI RARC to be used in the ~~ASC X12N 835~~ 005010X221 format. These codes are set forth in the Medical Billing and Payment Guide, Appendix B – 1.0 California DWC ANSI Matrix Crosswalk. Claims administrators should use the appropriate remittance remark codes to provide additional information to the health care provider regarding why a bill was adjusted or denied. Please note that RARC codes are required for certain Claim Adjustment Reason Codes.

7.6 California Jurisdictional EOR Statement ID Qualifier

The California paper Explanation of Review (EOR) process includes a requirement to provide health care providers, health care facilities, or ~~third party biller~~ billing agents/assignees with notice of “remedies,” i.e. specific information regarding how to seek Workers’ Compensation Appeals Board review of contested charges. For electronic billing/remittance, the California required EOR remedies statement is reflected as a jurisdictional code in the ~~ASC X12N 835~~ 005010X221. The jurisdictional code is populated in Other Claim Related Identification REF Segment in Loop 2100. The existing Reference Identification Qualifier “CE” Class of Contract Code is to be used as the qualifier in REF01 Segment for workers’ compensation to indicate the value in REF02. The Reference Identification value in REF02 is the 2 byte postal state abbreviation “CA” that represents the California EOR statement. California’s Jurisdictional REF02 “CA” code value equates to the following EOR statement (Labor Code § 4903.5):

A treating physician or authorized health care provider, health care facility, or ~~third party biller~~ billing agent/assignee may adjudicate the issue of the contested charges before the Workers' Compensation Appeals Board by filing a lien. Liens are subject to the statute of limitations spelled out in Labor Code § 4903.5.

- ~~4903.5.~~ (a) No lien claim for expenses as provided in subdivision (b) of Section 4903 may be filed after six months from the date on which the appeals board or a workers' compensation administrative law judge issues a final decision, findings, order, including an order approving compromise and release, or award, on the merits of the claim, after five years from the date of the injury for which the services were provided, or after one year from the date the services were provided, whichever is later.
- (b) Notwithstanding subdivision (a), any health care provider, health care service plan, group disability insurer, employee benefit plan, or other entity providing medical benefits on a nonindustrial basis, may file a lien claim for expenses as provided in subdivision (b) of Section 4903 within six months after the person or entity first has knowledge that an industrial injury is being claimed.

An objection to charges from a hospital, outpatient surgery center, or independent diagnostic facility shall be deemed sufficient if the health care provider, health care facility, or ~~third party biller~~ billing agent/assignee is advised, within the thirty working day period specified above, that a request has been made for an audit of the billing, when the results of the audit are expected, and contains the name, address, and telephone number of the person or office to contact for additional information concerning the audit.

Any contested charge for medical treatment provided or authorized by the treating physician which is determined by the appeals board to be payable shall carry interest at the same rate as judgments in civil actions from the date the amount was due until it is paid.

7.7 Product/Service ID Qualifier

The Product/Service Identification Number transmitted in the inbound electronic billing format is returned in the ~~ASC X12N 835~~ 005010X221 SVC Service Payment Information Segment with the appropriate qualifier. For example, a Revenue Code billed with a HCPCS on a UB-04 is transmitted to the Claims Administrator. The Revenue Code qualifier and Revenue Code are returned in the ~~ASC X12N 835~~ 005010X221, not the HCPCS Code.

7.8 California 835 Workers' Compensation Instructions

Instructions for California specific requirements are also provided in Chapter 2 California Workers' Compensation Requirements. When the application/instructions for California 835 workers' compensation are different than the HIPAA implementation, it is identified in the following table:

7.8.1 ~~ASC X12N 835 004010A1 Healthcare Claim Payment and Remittance Advice~~ ASC X12N/005010X221 Health Care Claim Payment/Advice (835)

Loop	Segment or Element	Value	Description	California Workers' Compensation Instructions
1000A	PER		Submitter Contact Information	
1000A	PER03	TE	Communication Number Qualifier	One occurrence of the PER Segment must have a value 'TE' Telephone Number.
1000A	PER04		Communication Number	One value must be the Telephone Number of the submitter.
2100	CLP		Claim Level Data	
2100	CLP06	WC	Claim Filing Indicator Code	Value must be 'WC' Workers' Compensation
2100	CLP07		Payor Claim Control Number	Value must be payor assigned claim control number (bill control number)
2100	REF		Other Claim Related Identification	California Jurisdictional EOR Code Statement Required ((Labor Code § 4903.5)
2100	REF01	CE	Reference Identification Qualifier	Value must be 'CE' Class of Contract Code
2100	REF02		Reference Identification	Reference Identification must be 'CA' California's Jurisdictional 2 byte postal state code 'CA' value equates to the EOR statement (Labor Code § 4903.5) as defined in this companion guide.
2100	REF		Other Claim Related Identification	Corrected Workers' Compensation Claim Number
2100	REF01	IL	Reference Identification Qualifier	Value must be 'IL' Group or Policy Number assigned by the payor.
2100	REF02		Reference Identification	Enter Corrected Workers' Compensation Claim Number assigned by the payor.
2100	DTM		Claim Date	Corrected Workers' Compensation Date of Accident / Injury / Illness
2100	DTM01	036	Date/Time Qualifier	Value must be '036' to indicate Corrected Workers' Compensation Date of Accident / Injury / Illness
2100	DTM02		Date	Enter Corrected Date of Accident / Injury / Illness

<u>Loop</u>	<u>Segment or Element</u>	<u>Value</u>	<u>Description</u>	<u>California Companion Guide Workers' Compensation Comments or Instructions</u>
1000A	PER		Submitter Contact Information	
	PER03	TE	Communication Number Qualifier	Value must be 'TE' Telephone Number.
	PER04		Communication Number	Value must be the Telephone Number of the submitter.
1000A	PER		Payer Web Site	If using the 2110 Loop REF Segment HealthCare Policy Identification to communicate the Jurisdictional Statutory/Citation Reason Code, then the PER Payer Web Site Segment is required to communicate the California Jurisdiction URL Statutory/Citation reference.
	PER01	IC	Contact Function Code	Value must be "IC"
	PER03	UR	Communication Number Qualifier	Value must be "UR" to indicate URL
	PER04		Communication Number	Enter the California Jurisdictional URL Statutory/Citation reference site (web link). The value must be http://www.dir.ca.gov/dwc/Laws_Regulations.htm
2100	CLP		Claim Level Data	
	CLP06	WC	Claim Filing Indicator Code	Value must be "WC" – Workers' Compensation
	CLP07		Payer Claim Control Number	Enter payer assigned claim control number (bill control number)
2100	REF		Other Claim Related Identification	Claim Level Jurisdictional EOR /EOB Code Statement (Labor Code § 4903.5)
	REF01	CE	Reference Identification Qualifier	Value must be "CE" Class of Contract Code
	REF02		Reference Identification	Reference Identification must be the State Jurisdiction 2 digit Postal Code. The State's Jurisdictional Postal code value equates to the EOR/ EOB statement (Labor Code § 4903.5) as defined in Chapter 7, section 7.6 of this companion guide.
2100	REF		Other Claim Related Identification	Insurance Policy Number. If an entire bill is denied at the claim level, using CARC code 191,214,221 or W1, then, use the Insurance Policy Number segment to report the appropriate California DWC Statute Code reference number.
	REF01	IG	Reference Identification Qualifier	Value must be 'IG'
	REF02		Reference Identification	Value must be the California DWC Statute code associated with the appropriate CARC code. Refer to the Medical Billing and Payment Guide Appendix B for California DWC Statute Codes associated with CARC Codes 191,214,221, or W1. Example: CARC 191 reason for denial is based on the DWC Labor Code §3600. The REF02 value would be '3600'.
2100	REF		Other Claim Related Identification	Corrected Workers' Compensation Claim Number
	REF01	1L	Reference Identification Qualifier	Value must be "1L" Group or Policy Number assigned by the payer
	REF02		Reference Identification	Enter Corrected Workers' Compensation Claim Number assigned by the payer
2100	DTM		Claim Date	Corrected Workers' Compensation Date of Accident/ Injury / Illness
	DTM01	036	Date/Time Qualifier	Value must be "036" to indicate Corrected Workers' Compensation Date of Accident/Injury / Illness
	DTM02		Date	Enter Corrected Date of Accident/Injury/Illness
2110	REF		HealthCare Policy Identification	Jurisdiction Statutory/Citation Reason Code : If a bill is reduced at the line level using CARC Codes 191,214, 221, or W1 use HealthCare Policy Identification segment to report the appropriate California DWC Statute Code reference number.
	REF01	OK	Reference Identification Qualifier	Value must be "OK"
	REF02		Reference Identification	Value must be the California DWC Statute code associated with the appropriate CARC code .Refer to the Medical Billing and Payment Guide Appendix B for California DWC Statute Codes associated with CARC Codes 191,214,221, or W1.

Chapter 8 Companion Guide ~~275 Additional Information to Support a Health Care Claim or Encounter~~ ASC X12N/005010X210 Additional Information to Support a Health Care Claim or Encounter (275) (Documentation/Medical Attachment)

The ~~ASC X12N 275-004050 Additional Information to Support a Health Care Claim or Encounter Implementation Guide~~ ASC X12N/005010X210 Additional Information to Support a Health Care Claim or Encounter (275) TR3 contains the recommended (but not required) standard electronic format for submitting documentation to support a bill. Health care providers, health care facilities, or ~~third party biller~~ billing agents/assignees and claims administrators may also elect to submit documentation associated with electronic bill transactions through facsimile (fax) or electronic mail (email) in accordance with Chapter 2, section 2.5.7 *Document/ Attachment Identification* and the Medical Billing and Payment Guide. Health care providers, health care facilities, or ~~third party biller~~ billing agents/assignees that engage in electronic billing and all claims administrators must be able to electronically exchange medical and other documentation that is required to be submitted with the bill based on the regulatory requirements.

8.1 Reference Information

The implementation guide for the ~~ASC X12N 275-004050 Additional Information to Support a Health Care Claim or Encounter Implementation Guide~~ ASC X12N/005010X210 Additional Information to Support a Health Care Claim or Encounter (275) TR3 is available through the Washington Publishing Company at <http://www.wpc-edi.com>.

8.2 Documentation Requirements

Documentation requirements for California workers' compensation billing are defined in the Medical Billing and Payment Guide in Section One – 7.3 Electronic Bill Attachments.

Chapter 9 Companion Guide Acknowledgments

The timeframes for transmitting acknowledgments, payment, and remittance advice, and for placing bills that are missing a claim number or attachment in a “pending status,” are set forth in the Medical Billing and Payment Guide, Chapter 7.

There are several different acknowledgments that are used to respond to the receipt of a bill by a clearinghouse and/or payor. The purpose of these acknowledgments is to provide the following feedback;

- 1) Basic file structure and the trading partner information from the Interchange Header.
- 2) Detailed structure and syntax of the actual bill data as specified by the X12 standard.
- 3) The content of the bill against the jurisdictional clean bill rules.
- 4) Any delays caused by claim number indexing/validation.
- 5) Any delays caused by attachment matching.
- 6) The outcome of the final adjudication, including reassociation to any financial transaction.

9.1 Clean Bill Acknowledgment Flow and Timing Diagrams

The process chart below shows how an incoming ASC X12N 837 Professional, Institutional and Dental 005010X222, 005010X223, or 005010X224 transaction is validated and processed by the receiver. The diagram shows the basic acknowledgments that are generated by the receiver, including those for validation and final adjudication for those bills that pass validation.

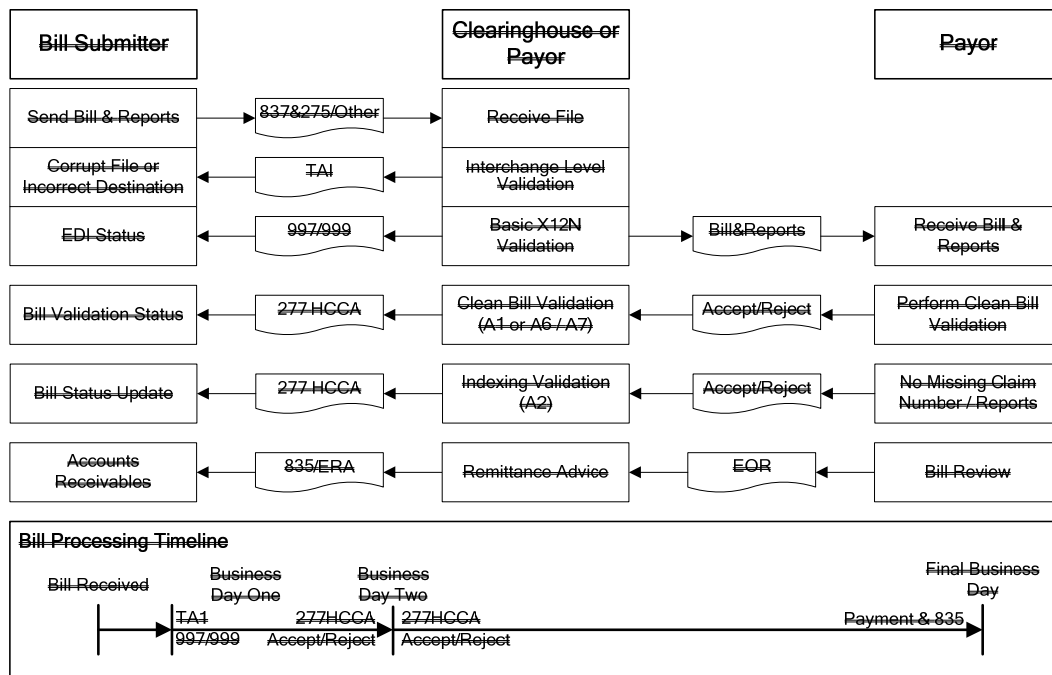

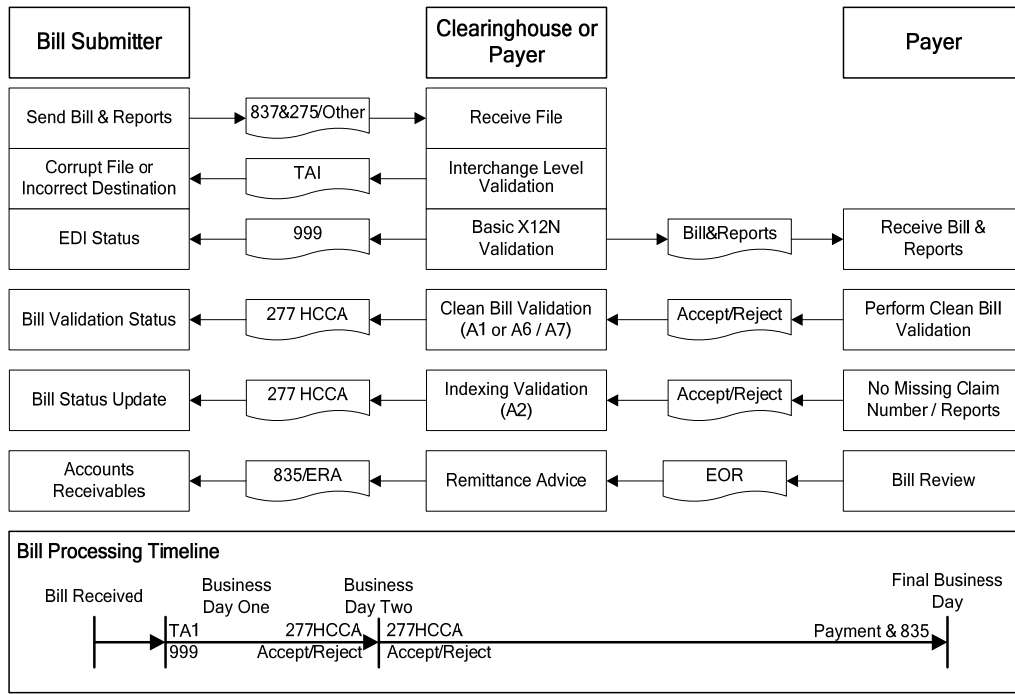

[Note for 15-day comment period: this new updated flow chart replaces the flow chart deleted with strikeout above.]

9.1.2 Process Steps

1. **Interchange Level Validation:** Basic file format and the trading partner information from the Interchange Header are validated. If the file is corrupt or is not the expected type the file is rejected. If the trading partner information is invalid or unknown, the file is rejected. A TA1 (Interchange Acknowledgement) is returned to indicate the outcome of the validation. A rejected EDI file is not passed on to the next step.
2. **Basic X12 Validation:** A determination will be made as to whether the transaction set contains a valid 837. A ~~997 (Functional Acknowledgement) or ASC X12C/005010X231 Implementation Acknowledgment (999)~~ will be returned to the submitter. ~~For 5010-837 a 999 should be returned and a 997 should be used with the 4010A1-837. The 997 or 005010X231 contains ACCEPT or REJECT of the Functional Acknowledgment information. If the file contains syntactical errors, the locations of the errors are reported. Bills that are part of a rejected transaction set are not passed on to the next step. Note: A trading partner under mutual agreement may also send the 999 with the same level of X12 validation as the 997. Only one, either a 997 or 999 may be sent for this validation layer.~~
3. **Clean Bill Validation:** The jurisdictional and payor specific edits are run against each bill within the transaction set. A ~~277 HCCA (Health Care Claim Acknowledgement)~~ ASC X12N/005010X214 Health Claim Acknowledgment (277) is returned to accept or reject the bills. Bills that are rejected are not passed on to the next step.
4. **Clean Bill – Missing Claim Number and or Missing Required Report:** Refer to Section 9.2 Clean Claim-Missing Claim Number Pre Adjudication Holding (Pending) Status and Section 9.2 Clean Claim- Missing Report Pre-Adjudication Hold (Pending) Status regarding bill acknowledgment flow and timeline diagrams.
5. **Bill Review:** The bills that pass through bill review and any post-bill review approval process will be reported in the ~~835 Remittance Advice~~ ASC X12N/005010X221 Payment/Advice (835). The ~~835 005010X221~~ contains the adjudication information from each bill, plus any paper check or EFT payment information.

9.2 Clean Bill-Missing Claim Number Pre-Adjudication Hold (Pending) Status

One of the processing steps that a bill goes through prior to adjudication is to verify that the bill concerns an actual employment-related condition that has been reported to the employer and subsequently reported to the claims administrator. This process, usually called “claim indexing/validation” can cause a delay in the processing of the bill. Once the validation process is complete, a claim number is assigned to the injured worker’s claim. This claim number is necessary for the proper processing of the bill. Until the claim number is provided to the bill submitter, it cannot be included on the ~~ANSI ASC X12N 837~~ 005010X222, 005010X223, or 005010X224 (837) for submission to the payor. In order to prevent medical bills from being rejected due to lack of a claim number, a pre-adjudication hold (pending) period of up to five business days is mandated to enable the payor to attempt to match the bill to an existing claim in their system. If the bill cannot be matched within the five days, the bill may be rejected as incomplete. If the payor is able to match the bill to an existing claim, it should attach the claim number to the transaction and put it through the adjudication process. The claim number should then be provided to the bill submitter using the ASCX12N ~~277 HCCA~~ 005010X214 for use in future billing. The ASCX12N ~~277 HCCA~~ 005010X214 is also used to inform the bill submitter of the delay and the ultimate resolution of the issue. Once the claim number has been provided to the bill submitter, subsequent bill submissions are not subject to the pre-adjudication hold status and may be denied for being incomplete due to lack of the claim number.

Due to the pre adjudication hold (pending) status a payor may send one STC segment with up to three claim status composites (STC01, STC10, and STC11) in a ~~277 HCCA-005010X214~~. When a clean claim has a missing claim number and a missing report, the one STC segment in the ~~277 HCCA-005010X214~~ would have the following three claim status composites: STC01, STC10 and STC11.

An Example: STC*A1:21*20090830*U*70*****A1:629*A1:294~

When a clean bill is only missing a claim number or missing a report the one STC segment in the ~~277 HCCA~~ 005010X214 would have the following two claim status composites: STC01 and STC10:

An Example: STC*A1:21*20090830*U*70*****A1:629~

A bill submitter could potentially receive two ~~277 HCCA~~ 005010X214 transmissions as a result of the pre adjudication hold (pending) status.

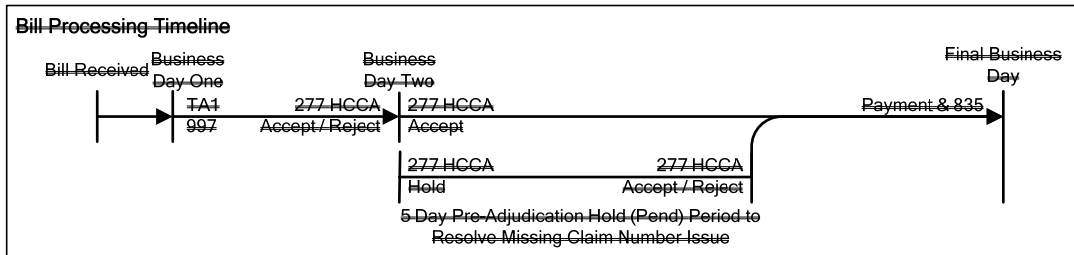
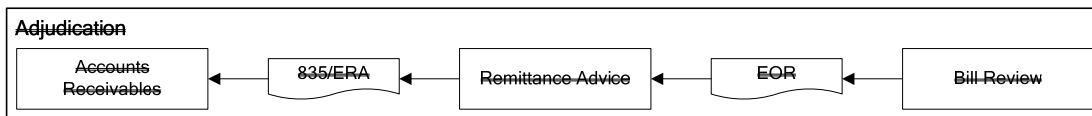
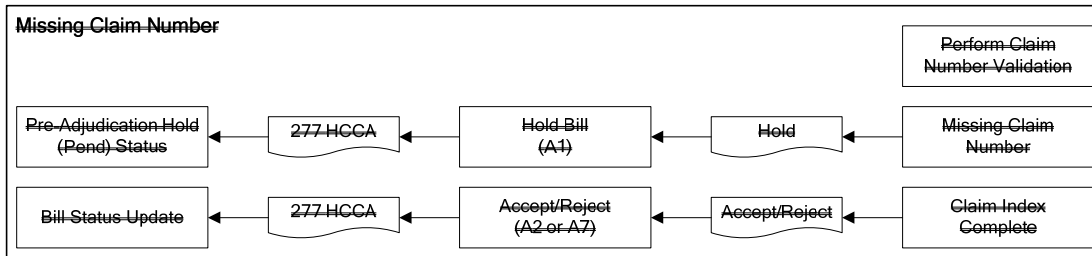
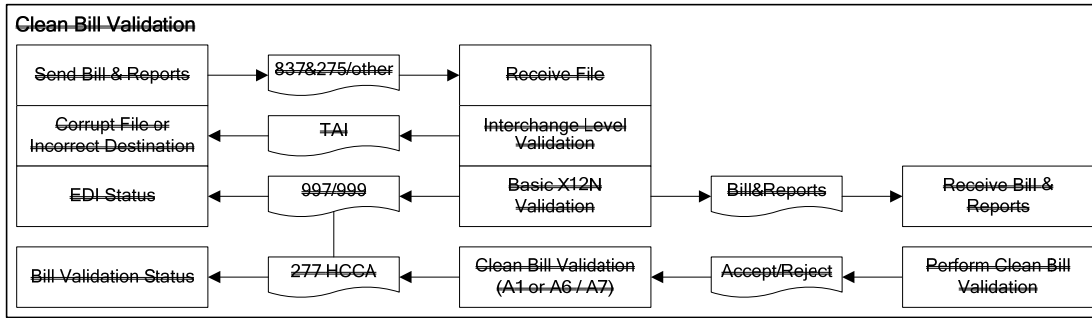
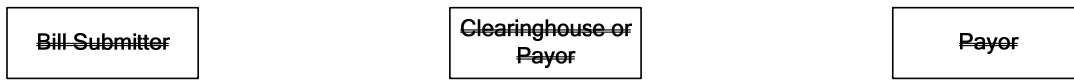

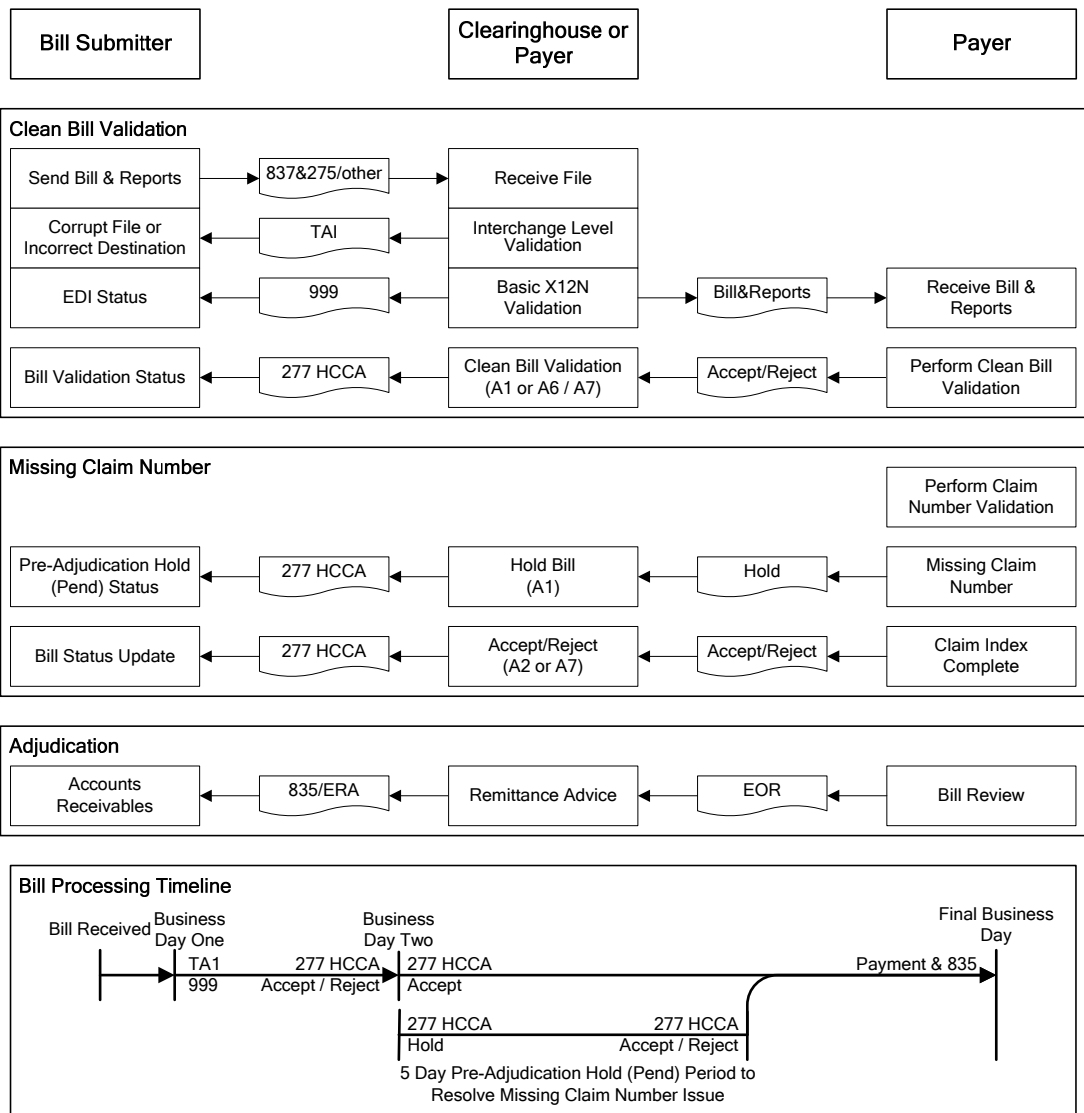

[Note for 15-day comment period: this new updated flow chart replaces the flow chart deleted with strikeout above.]

9.2.1 Missing Claim Number-~~277 Health Care Claim Acknowledgment ASC X12N/005010X214 Health Care Claim Acknowledgment (277)~~

Process Steps

When the ~~ASC X12N 837 005010X222, 005010X223, or 005010X224 (837)~~ transaction has passed the clean bill validation process and Loop 2010 CA REF02 indicates that the workers’ compensation claim number is “unknown” the payor will need to respond with the appropriate ~~ASC X12N 277 HCCA 005010X214~~ response (s) as applicable:

<p>Claim Number Validation Status</p>	<p>277 HCCA Acknowledgment ASC X12N/005010X214 Health Care Claim Acknowledgment (277)</p>
<p>Clean Bill - Missing Claim Number</p>	<p>If the payor needs to pend an otherwise clean bill due to a missing claim number, then use the following Claim Status Category Code and Claim Status Code:</p> <p>STC01-1 = A1 The claim/encounter has been received. This does not mean that the claim has been accepted for adjudication.</p> <p>STC01-2= 21 (Missing or Invalid Information)</p> <p>AND `</p> <p>STC10 -1 = ` A1 The claim/encounter has been received. This does not mean that the claim has been accepted for adjudication.</p> <p>STC10-2 = 629 Property Casualty Claim Number</p> <p>Example: STC*A1:21*20090830*U*70*****A1:629~</p>
<p>Claim Index/Validation Complete</p>	<p>277 HCCA Acknowledgment ASC X12N/005010X214 Health Care Claim Acknowledgment (277)</p>
<p>Claim was Found</p>	<p>Once the Claim Indexing/ Validation process has been completed and there is a bill/ claim number match, then use the following Claim Status Category Code with the appropriate Claim Status Code:</p> <p>STC01-1 = A2 Acknowledgment/Acceptance into adjudication system-The claim/encounter has been accepted into the adjudication system.</p> <p>STC01-2 = 20 Accepted for processing</p> <p>Payor Claim Control Number: Use Loop 2200D REF segment “Payor Claim Control Number with qualifier 1K Identification Number to return the workers’ compensation claim number and or the payor bill control number in the REF02:</p> <ol style="list-style-type: none"> a. Always preface the workers’ compensation claim number with the two digit qualifier “Y4” followed by the property casualty claim number. Example: Y412345678 b. If there are two numbers (payor claim control number and the workers’ compensation claim number) returned in the REF02, then use a blank space to separate the numbers. <ul style="list-style-type: none"> - The first number will be the payor claim control number- assigned by the payor (bill control number). - The second number will be the workers’ compensation property and casualty claim number assigned by the payor with a “Y4” qualifier followed by the claim number. <p>-Example: REF*1K*3456832 Y43333445556~</p>
<p>No Claim Found</p>	<p>After the Claim Indexing/ Validation process has been completed and there is no bill/ claim number match, then use the following Claim Status Category Code with the appropriate Claim Status Code:</p>

	<p>STC01-1 = A6 Acknowledgment/Rejected for Missing Information - The claim/encounter is missing the information specified in the Status details and has been rejected.</p> <p>STC01-2 = 629 Property Casualty Claim Number (No Bill/Claim Number Match)</p>
--	--

9.3 Clean Bill-Missing Report Pre - Adjudication Hold (Pending) Status

One of the processing steps that a bill goes through prior to adjudication is to verify if all required documentation has been provided. The bill submitter can send the reports using the ~~ASCX12N 275~~ ASC X12N/005010X210 Additional Information to Support a Health Care Claim or Encounter (275) or other mechanisms such as fax or e-mail. In order to prevent medical bills from being rejected due to lack of a required piece of documentation coming separately from the bill itself, a pre-adjudication holding (pending) period of up to five business days is mandated to enable the payor to receive and match the bill to the documentation. If the bill cannot be matched within the five days, or the documentation is not received, the bill may be rejected as incomplete. If the payor is able to match the bill to the documentation within the five days, it should put the bill through the adjudication process. The ~~ASCX12N 277 HCCA~~ ASC X12N/005010X214 Health Care Claim Acknowledgment (277) is used to inform the bill submitter of the delay and the ultimate resolution of the issue.

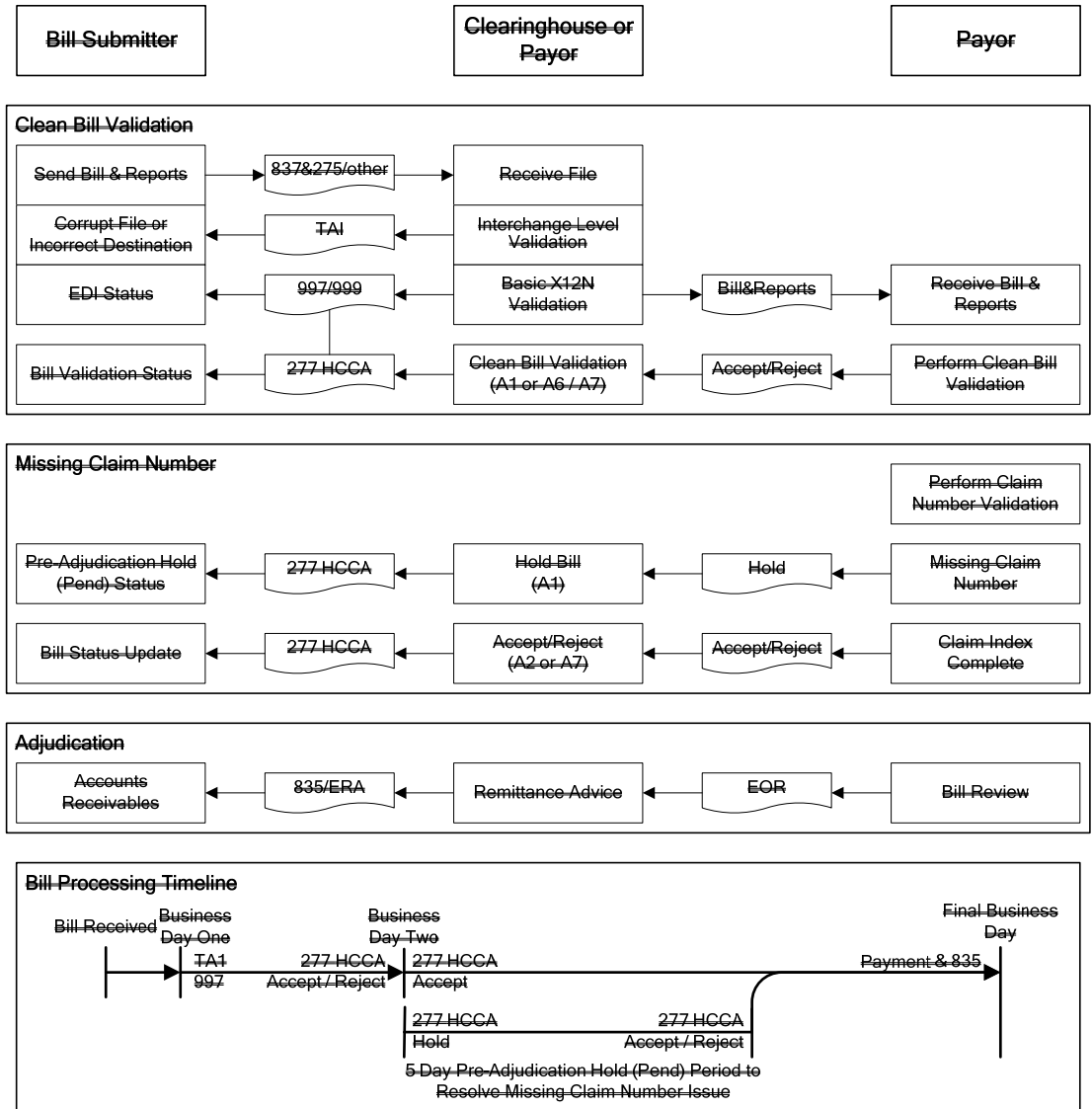

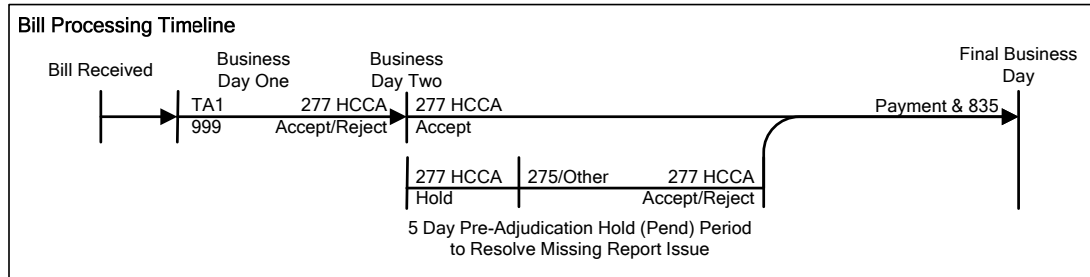
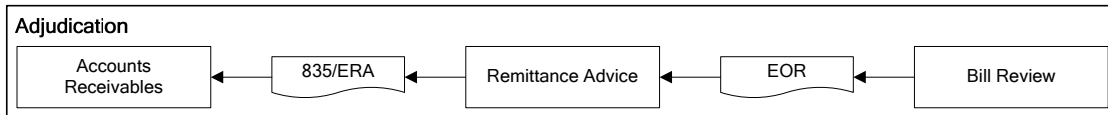
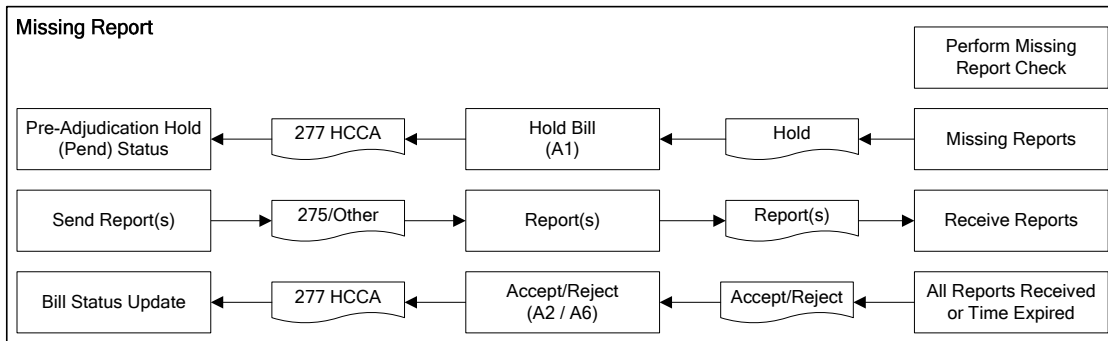
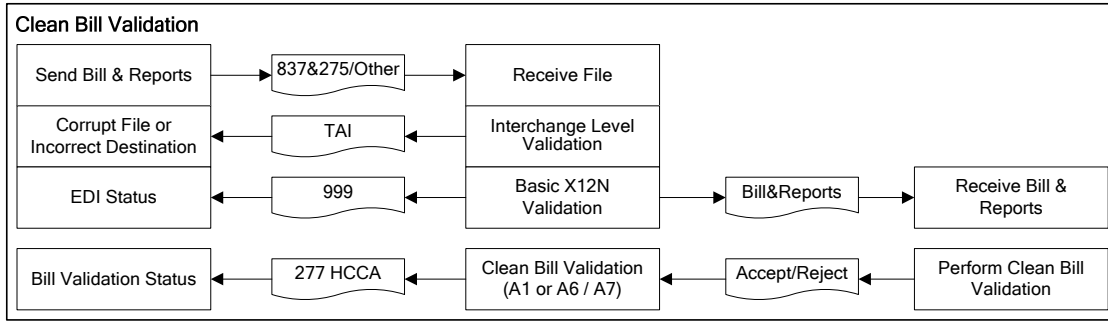
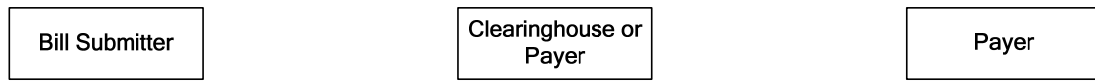

[Note for 15-day comment period: this new updated flow chart replaces the flow chart deleted with strikeout above.]

9.3.1 Missing Report - ~~ASC X12N 277 Health Care Claim Acknowledgement~~ ASC X12N/005010X214 Health Care Claim Acknowledgment (277)

Process Steps

When a bill submitter sends an ~~ASC X12N 837 005010X222, 005010X223, or 005010X224 (837)~~ that requires an attachment and Loop 2300 PWK Segment indicates there is a report that will be following , the payor will need to respond with the appropriate ~~ASC X12N 277 HCCA~~ ASC X12N/005010X214 Health Care Claim Acknowledgment (277) response (s) as applicable:

Bill Status Findings	277 HCCA Acknowledgement <u>ASC X12N/005010X214 Health Care Claim Acknowledgment (277) Options+</u>
Clean Bill- Missing Report	<p>When a clean bill is missing a required report, then the payor needs to place the bill in a pre-adjudication hold (pending) status during the specified waiting time period and send the following Claim Status Category Code and Claim Status Code:</p> <p>STC01-1 = A1 The claim/encounter has been received. This does not mean that the claim has been accepted for adjudication.</p> <p>STC01-2 = 21 (Missing or Invalid Information)</p> <p>AND</p> <p>STC10-1 = A1 The claim/encounter has been received. This does not mean that the claim has been accepted for adjudication</p> <p>STC10-2 = Use the appropriate 277 Claim Status Code for missing report type <i>Example: Claim Status Code 294 Supporting documentation</i></p> <p>Example :STC*A1:21*20090830*U*70***A1:294~:</p>
Report Received within the 5 day pre-adjudication hold (pending) period	<p>Use the following Claim Status Category Code and Claim Status Code:</p> <p>STC01-1= A2 Acknowledgment/Acceptance into adjudication system-The claim/encounter has been accepted into the adjudication system.</p> <p>STC01-2=20 Accepted for processing</p>
No Report Received within the 5 day pre-adjudication hold (pending) period	<p>Use the following Claim Status Category Code and Claim Status Code.</p> <p>STC01-1= A6 Acknowledgment/Rejected for Missing Information - The claim/encounter is missing the information specified in the Status details and has been rejected.</p> <p>STC01-2=294 Supporting documentation</p>

9.4 Transmission Responses

9.4.1 ASC X12N TA1 - Interchange Acknowledgement

The ASC X12N Interchange Acknowledgement, or TA1, found within the ASC X12C/005010X231 Implementation Acknowledgment for Health Care Insurance, is ~~generally~~ used to provide the bill submitter negative confirmation of the transmission of the interchange control envelope portion of the EDI file transmission. The TA1 reports the syntactical analysis of the interchange header and trailer. If invalid (i.e. the data is corrupt or the trading partner relationship does not exist) the edit will reject and a TA1 will be returned. The entire transaction is rejected at the header level. The TA1 is only returned if the inbound ISA14 is set to a 1 whether or not the interchange is accepted or rejected.

9.4.2 ~~ASC X12N 997 – Functional Acknowledgement~~ ASC X12C/005010X231 - Implementation Acknowledgement for Health Care Insurance (999)

~~If the trading partners are using version 4010 of ASC X12N standard, the ASC X12N 997~~ The ASC X12C/005010X231, or Functional Implementation Acknowledgement for Health Care Insurance (999), is used to provide the submitter a positive or negative confirmation of the structure of the 837 EDI file. If the 837 file contained syntactical errors, the segment(s) and element(s) where the error(s) occurred will be reported.

9.4.3 ~~ASC X12N 277 – Health Care Claim Acknowledgement~~ ASC X12N/005010X214 Health Care Claim Acknowledgment (277)

The word “claim” refers to the bill for medical services or goods, not the injured worker’s claim for workers’ compensation benefits. ~~The ASC X12N 277 Health Care Claim Acknowledgement~~ ASC X12N/005010X214 Health Care Claim Acknowledgment (277) is used to provide the bill submitter with a positive or negative confirmation of each bill within the EDI file. The 277 details what errors are present, and if necessary, what action the submitter should take. ~~The ASC X12N 004040X167 277~~ 005010X214 should be used. Payors need to use the most current claim status category and claims status codes as they are subject to change as maintenance on these codes is done three times a year.

Most of the segments in the ~~277~~ 005010X214 are used to identify which claim or service line is being acknowledged. The STC segment in the ~~277~~ 005010X214 relays the status of the claim.

The STC segment is primarily made up of four fields:

- STC01 the claim status code composite
- STC02 the effective date of the status
- STC03 the action code; accept or reject
- STC04 original claim charge amount

Note: There are two additional composites that are available (STC10 and STC11) to provide a more bill status message, particularly when there is missing information.

The STC01 field is made up of four sub fields:

- STC01-1 the status category code. Used to show if the status indicates a reject, accept, etc
- STC01-2 the status code. Usually indicates the bill field that has a problem.
- STC01-3 an optional entity type. Used when STC01-2 is an entity, to further refine the definition of the entity.

STC01-4 the status code list qualifier code. Always 65 for the ~~4040X167 277 HCCA~~, 005010X214

The following are the most common scenarios and STC01 values:

- 1) Claim was accepted and forwarded to another clearing house.
 - STC01-1 = A0 (acknowledgment/forwarded)
 - STC01-2 = 16 (claim has been forwarded to entity)
 - STC01-3 = List the entity
- 2) Claim was accepted for further processing (pre- adjudication hold pend status).
 - STC01-1 = A1 (acknowledgment/received but does not mean the bill was accepted into the payor’s adjudication system)

STC01-2 = 21 (Missing or Invalid Information)

STC10-1 = A1 (acknowledgement/received but does not mean the bill was accepted into the payor's adjudication system)

STC10-2 = 629 Property Casualty Claim Number

3) Claim was accepted by the payor for adjudication. An optional response based on level of feedback from the payor.

STC01-1 = A2 (acknowledgement/accepted into adjudication system)

STC01-2 = 20 (accepted for processing)

4) Claim was accepted and split into multiple claims.

STC01-1 = A5 (acknowledgement/split)

STC01-2 = 20 (accepted for processing)

5) Claim was rejected for missing information.

STC01-1 = A6 (acknowledgement/rejected for missing information)

STC01-2 = code indicating the missing data

STC01-3 = optional code indicating the entity type

6) Claim was rejected for invalid information.

STC01-1 = A7 (acknowledgement/rejected for invalid information)

STC01-2 = code indicating the invalid data

STC01-3 = optional code indicating the entity type

9.4.4 ~~ASC X12N 835 – Remittance Advice~~ ASC X12N/005010X221 Health Care Claim Payment/Advice (835)

The ~~ASC X12N 835 Remittance Advice~~ ASC X12N/005010X221 Health Care Claim Payment/Advice (835) is used as a replacement for a paper remittance advice. The ~~ASC X12N 835 Remittance Advice 005010X221~~ will be delivered to the bill submitter. It is used to communicate claims processing decisions relating to payment, adjustment, or denial of the bill. See Chapter 7 for further detail regarding the ~~835 Remittance Advice 005010X221~~.

Appendix A – Glossary of Terms

Acknowledgment	Electronic notification to original sender of an electronic transmission or the transactions within the transmission were accepted or rejected.
ADA	American Dental Association.
ADA-2006	American Dental Association (ADA) standard paper billing form.
AMA	American Medical Association
ANSI	American National Standards Institute is a private, non-profit organization that administers and coordinates the U.S. voluntary standardization and conformity assessment system.
<u>ANSI X12 275 ASC X12N/005010X210 Additional Information to Support a Health Care Claim or Encounter (275)</u>	National standard format for attachments/documentation. The 275 format is being reviewed for possible adoption as a HIPAA standard format.
<u>ANSI X12 835 ASC X12N/005010X221 Payment/Advice (835)</u>	HIPAA compliant national standard remittance/reimbursement format.
<u>ANSI X12 837 ASC X12N/005010X222, 005010X223, or 005010X224 (837)</u>	HIPAA compliant national standard billing format for professional services (837 P), hospital/facility services (837 I), and dental services (837 D).
<u>ANSI X12 997 ASC X12C/005010X231 - Implementation Acknowledgment (999)</u>	HIPAA compliant national standard functional acknowledgment format.
CDT	Current Dental Terminology coding system used to bill dental services.
Clearinghouse	An entity that processes information received in a nonstandard format or containing nonstandard data content into a standard transaction, or that receives a standard transaction and processes that information into a nonstandard transaction
CMS	Centers for Medicare and Medicaid Services, of U.S. Dept. of Health and Human Services.
CMS-1450	The paper hospital, institutional or facility billing form also referred to as a UB-04.
CMS-1500	The paper professional billing form formerly referred to as a HCFA or HCFA-1500.

Code Sets	Tables or lists of codes used for specific purposes. National standard formats may use code sets developed by the standard setting organization (i.e. ANSI Provider Type qualifiers) or by other organizations (i.e. HCPCS codes).
CPT	Current Procedural Terminology is the coding system created and copyrighted by the American Medical Association used to bill professional services.
DEA	Drug Enforcement Agency
DEA Number	Prescriber DEA identifier used for pharmacy billing.
Detail Acknowledgment	Electronic notification to original sender of an electronic transmission or the transactions within the transmission were accepted or rejected.
DWC	Division of Workers' Compensation of the California Dept. of Industrial Relations.
Electronic Bill	A bill submitted from the health care provider, health care facility, or third party biller <u>billing agent</u> /assignee to the payor electronically.
EFT	Electronic Funds Transfer.
Electronic Format	The specifications defining the layout of data in an electronic transmission.
Electronic Record	A group of related data elements. A record may represent a line item, a health care provider, health care facility, or third party biller <u>billing agent</u> /assignee, or an employer. One or more records may form a transaction.
Electronic Transaction	A set of information or data stored electronically in a defined format that has a distinct and different meaning as a set. An electronic transaction is made up of one or more electronic records.
Electronic Transmission	Transmission of information by electronic data interchange.
EOB/EOR	Explanation of Benefits (EOB) or Explanation of Review (EOR) is paper form sent by the Claims Administrator to the health care provider, health care facility, or third party biller <u>billing agent</u> /assignee to explain payment or denial of a medical bill. The EOB/EOR might also be used to request a recoupment of an overpayment or acknowledge receipt of a refund.
Functional Acknowledgment	Electronic notification to original sender of an electronic transmission that the functional group within the transaction was accepted or rejected.
HCPCS	Health Care Common Procedure Coding System is the HIPAA code set used to bill durable medical equipment, prosthetics, Orthotics, supplies, and biologics (Level II) as well as professional services (Level I). Level I HCPCS codes are CPT codes.
HIPAA	Health Insurance Portability and Accountability Act, federal legislation that includes provisions that mandate electronic billing in the Medicare system and establishes national standard electronic file formats and code sets.
IAIABC	International Association of Industrial Accident Boards and Commissions.

IAIABC 837	A version of the ANSI 837 electronic file format adopted by IAIABC for Claims Administrator-to-jurisdiction reporting of medical bill payment data.
ICD-9	International Classification of Diseases, the code set administered by the World Health Organization used to identify diagnoses.
MPN	Medical Provider Network as defined by California Labor Code § 4614.
NCPDP	National Council on <u>for</u> Prescription Drug Programs.
<u>NCPDP WC/PC UCF</u>	<u>National Council for Prescription Drug Programs Workers' Compensation/Property and Casualty Universal Claim Form which is the pharmacy industry standard for pharmacy claims billing on paper forms.</u>
NCPDP Telecommunication 5.1 D.0	HIPAA compliant national standard billing format for pharmacy services.
NDC	National Drug Code, code set used to identify medication dispensed by pharmacies.
NPI	National Provider Identification Number, obtained from CMS.
OMFS	California Official Medical Fee Schedule, established pursuant to Labor Code § 5307.1.
PBM	Pharmacy Benefit Manager.
PPO	Preferred Provider Organization
Receiver	The entity receiving/accepting an electronic transmission.
Remittance	Remittance is used in the electronic environment to refer to reimbursement or denial of medical bills.
Sender	The entity submitting an electronic transmission.
TPA	Third Party Administrator.
Trading Partner	Parties to an electronic transaction.
UB-04	Universal billing form used for hospital billing.
UCF	Universal Claim Form, NCPDP proprietary pharmacy billing form.
Version	Electronic formats may be modified in subsequent releases. Version naming conventions indicate the release or version for a format. Naming conventions are administered by the standard setting organization. Some ANSI formats, for example, are 3050, 4010, and 4050.

Appendix B – Code Set References

The table below provides a matrix of the code sets referenced in the companion guide.

Code Set	Definition	Publishing Entity
APPLICATION ACKNOWLEDGMENT CODE	A code used to identify the accepted/rejected status of the transaction being acknowledged.	Washington Publishing Company 10940 NE 33rd Place, Suite 204 Bellevue, WA 98004 (425) 562-2245 - Voice (775) 239-2061 - Fax http://www.wpc-edi.com
BASIS OF COST DETERMINATION	Method by which drug cost was calculated. Used for statistical analysis and cost comparison.	National Council for Prescription Drug Programs, (NCPDP) www.ncdp.org 9240 E. Raintree Dr. Scottsdale, Arizona 85260-7518
BILL SUBMISSION REASON CODE	Code indicating bill submission/re-submission type. Determine status and reason for submission; monitors medical costs.	Washington Publishing Company 10940 NE 33rd Place, Suite 204 Bellevue, WA 98004 (425) 562-2245 - Voice (775) 239-2061 - Fax http://www.wpc-edi.com
BILLING TYPE CODE	Code indicating type of bill. Statistical analysis and audit information, tracing medical costs.	National Uniform Billing Committee American Hospital Association www.nubc.org/ One North Franklin, Chicago, IL 60606-3421
CDT Code	American Dental Association Codes on Dental Procedure and Nomenclature (Current Dental Terminology) used to identify dental procedure billed & paid.	American Dental Association http://www.ada.org/ 211 East Chicago Ave. Chicago, IL 60611-2678
CLAIM ADJUSTMENT GROUP CODE	Codes indicating general category of payment adjustment at the bill level and service line. Identifies potential litigation; tracking medical costs; used for statistical analysis.	Washington Publishing Company 10940 NE 33rd Place, Suite 204 Bellevue, WA 98004 (425) 562-2245 - Voice (775) 239-2061 - Fax http://www.wpc-edi.com

Code Set	Definition	Publishing Entity
CLAIM ADJUSTMENT REASON CODE	Codes indicating detailed reason an adjustment was made at the bill and service line levels.	Washington Publishing Company 10940 NE 33rd Place, Suite 204 Bellevue, WA 98004 (425) 562-2245 - Voice (775) 239-2061 - Fax http://www.wpc-edi.com
COUNTRY CODE	Code indicating country of the billing provider's mailing address. Identify provider's location; reimbursement determination.	U.S. Postal Service www.usps.com/
DISPENSE AS WRITTEN CODE	A code denoting methodology utilized in dispensing medication. Measuring medical cost trends; managed care certification, impact of medical treatment guidelines.	National Council for Prescription Drug Programs, (NCPDP) www.ncpdp.org/ 9240 E. Raintree Dr. Scottsdale, Arizona 85260-7518
DRG CODE or MS-DRG CODE	"Diagnosis Related Group (DRG)" or "Medicare Severity-DRG" means Medicare Severity Diagnosis Related Group inpatient classification scheme used by CMS for hospital inpatient reimbursement. The DRG system classifies patients based on principal diagnosis, surgical procedure, presence of comorbidities and complications and other pertinent data.	Center for Medicare and Medicaid Services (CMS) http://www.cms.hhs.gov/ 7500 Security Boulevard Baltimore, MD 21244
DWC BILL ADJUSTMENT REASON CODE	The DWC Bill Adjustment Reason Codes are a group of codes developed by the California Division of Workers' Compensation to describe the specific reasons why a particular billed code has not been paid or has been paid at a different rate than that which was billed or to request additional information.	The DWC Medical Billing and Payment Guide DWC – Fee Schedules P.O. Box 71010 Oakland, CA 94612
ELEMENT ERROR NUMBER	A number to uniquely identify the edit performed on an element and is part of the error code.	Washington Publishing Company 10940 NE 33rd Place, Suite 204 Bellevue, WA 98004 (425) 562-2245 - Voice (775) 239-2061 - Fax http://www.wpc-edi.com

Code Set	Definition	Publishing Entity
HCPCS PROCEDURE CODE	HCPCS (Health Care Common Procedure Coding System) code billed and paid. Procedure codes identify treatment rendered for professional services, durable medical equipment, prosthetics, orthotics, and medical supplies.	American Medical Association www.ama-assn.org/ 515 N. State Street Chicago, IL 60610
Hospital Admission Type Code	Code indicating admission priority. Identifies potential reimbursement formulas and pre-authorization of services.	National Uniform Billing Committee American Hospital Association www.nubc.org/ One North Franklin, Chicago, IL 60606-3421
Hospital BILL FREQUENCY TYPE CODE	Code indicating claim billing status. Statistical analysis and audit information.	National Uniform Billing Committee American Hospital Association www.nubc.org/ One North Franklin, Chicago, IL 60606-3421
Hospital FACILITY CODE	Code indicating type of facility where treatment was rendered. Utilization review, audit, statistical analysis.	National Uniform Billing Committee American Hospital Association www.nubc.org/ One North Franklin, Chicago, IL 60606-3421
HOUR	The time claimant was admitted / discharged from the facility. Determine length of stay.	National Uniform Billing Committee American Hospital Association www.nubc.org/ One North Franklin, Chicago, IL 60606-3421
ICD-9-CM Diagnosis Code	International Classification of Diseases, Ninth Revision, Clinical Modification, Volumes 1 and 2, describes the classification or morbidity and mortality information for statistical purposes and the indexing of hospital records by disease and operations.	World Health Organization through the Centers for Disease Control, National Center for Health Statistics (NCHS) responsible for maintaining codes. http://www.cdc.gov/nchs/icd.htm
ICD-9-CM Procedure Code	International Classification of Diseases, Ninth Revision, Clinical Modification Volume 3, Procedure Codes - classification system for surgical, diagnostic, and therapeutic procedures.	World Health Organization through the Centers for Disease Control, National Center for Health Statistics (NCHS) responsible for maintaining codes. http://www.cdc.gov/nchs/icd.htm

Code Set	Definition	Publishing Entity
NDC CODE	NDC (National Drug Code) identifying drugs or pharmaceuticals billed. The National Drug Code is a coding convention established by the Food and Drug Administration to identify the labeler, product number, and package sizes of FDA-approved prescription drugs..	Food and Drug Administration http://www.fda.gov/cder/ndc/ 5600 Fishers Lane, HFD-240 Rockville, MD 20857
NPI	National Provider Identifier (NPI) assigned by CMS.	Center for Medicare and Medicaid Services (CMS) http://www.cms.hhs.gov/ 7500 Security Boulevard Baltimore, MD 21244
PLACE OF SERVICE	Identifies location where professional services were rendered.	Center for Medicare and Medicaid Services (CMS) http://www.cms.hhs.gov/ 7500 Security Boulevard Baltimore, MD 21244
POSTAL CODE	Postal code (zip code) of provider's mailing address of the billing provider. Identification of provider; monitor health care providers for compliance with fee and treatment guidelines.	U.S. Postal Service www.usps.com/
PRESCRIBER DEA NUMBER	Drug Enforcement Agency of the Federal Justice Department assigns a unique number to physicians prescribing controlled substances.	Federal Drug Enforcement Agency www.usdoj.gov/dea/ 2401 Jefferson Davis Highway Alexandria, VA 22301
PROVIDER LICENSE NUMBER	Unique provider identification number assigned by a licensing/certifying entity.	Licensing/certifying boards or commissions.
PROVIDER TAXONOMY CODES	Code indicating primary medical specialty of billing provider. Identification of provider; monitor health care providers for compliance with fee and treatment.	Washington Publishing Company 10940 NE 33rd Place, Suite 204 Bellevue, WA 98004 (425) 562-2245 - Voice (775) 239-2061 - Fax http://www.wpc-edi.com
REMITTANCE ADVICE REMARK CODES	Convey information about remittance processing or to provide a supplemental explanation for an adjustment already described by a Claim Adjustment Reason Code.	Washington Publishing Company 10940 NE 33rd Place, Suite 204 Bellevue, WA 98004 (425) 562-2245 - Voice (775) 239-2061 - Fax http://www.wpc-edi.com

Code Set	Definition	Publishing Entity
REVENUE BILLED & PAID CODE (B5)	Code indicating specific cost center billed and paid. Determines reimbursement and treatment provided or specific cost center paid.	National Uniform Billing Committee American Hospital Association www.nubc.org/ One North Franklin, Chicago, IL 60606-3421
Rx NCPDP Number	National Council of Prescription Drug Programs pharmacy identification number	National Council of Prescription Drug Programs www.ncdp.org/ 9240 E. Raintree Dr. Scottsdale, Arizona 85260-7518
STATE CODE	State code of provider's mailing address of the billing provider. Identify provider's location; reimbursement determination.	U.S. Postal Service www.usps.com/
Tooth Letter	American Dental Association letter assigned to represent primary teeth.	American Dental Association http://www.ada.org/ 211 East Chicago Ave. Chicago, IL 60611-2678
Tooth Number	American Dental Association number assigned to represent permanent teeth.	American Dental Association http://www.ada.org/ 211 East Chicago Ave. Chicago, IL 60611-2678
Tooth Surface Code	American Dental Association letter used to designate tooth surface.	American Dental Association http://www.ada.org/ 211 East Chicago Ave. Chicago, IL 60611-2678

Appendix C – Jurisdictional Report Type Codes and DWC Descriptions

OZ -Jurisdictional List of Report Type Codes	California DWC Description
J1 Doctor First Report of Injury	A Doctor's First Report of Occupational Injury (DLSR 5021), must be submitted when the bill is for Evaluation and Management services and a Doctor's First Report of Occupational Injury is required under Title 8, California Code of Regulations § 9785.
J2 Supplemental Medical Report	This is to be used when billing for a "By Report" code or any other additional type of supplemental report.
J3 Medical Permanent Impairment Report	Do not use
J4 Medical Legal Report	A Medical-Legal report is a report submitted by a QME, AME or the Primary Treating Physician when addressing a disputed medical issue.
J5 Vocational Report	
J6 Work Status Report	
J7 Consultation Report	A narrative report must be submitted when the bill is for Evaluation and Management services for a consultation.
J8 Permanent Disability Report	A PR-3, PR-4 or their narrative equivalent must be submitted when the bill is for Evaluation and Management services and the injured worker's condition has been declared permanent and stationary with permanent disability or a need for future medical care. (Use of Modifier – 17)
J9	Itemized Statement
09 Progress Report	A PR-2 report or its narrative equivalent must be submitted when the bill is for Evaluation and Management services and a PR-2 report is required under Title 8, California Code of Regulations § 9785.
10 Continued Treatment	To be used when submitting a Functional Improvement Report.
11 Chemical Analysis	
13 Certified Test Report	
06 Initial Assessment	Physical Therapy or Occupational Therapy initial assessment report
21 Recovery Plan	
A3 Allergies/Sensitivities Document	

OZ -Jurisdictional List of Report Type Codes	California DWC Description
A4 Autopsy Report	
AM Ambulance Certification	
DB Durable Medical Equipment Prescription	
DJ Discharge Monitoring Report	
LA Laboratory Results	
M1 Medical Record Attachment	
OD Orders and Treatments Document	
P4 Pathology Report	
PY Physician's Report	
V5 Death Notification	
XP Photographs	

Appendix D – Security Rule

SECURITY RULE TO PROTECT THE CONFIDENTIALITY OF MEDICAL INFORMATION SUBMITTED ELECTRONICALLY

1.0 Introduction

Health care providers, health care facilities, ~~third party billers~~ billing agents/assignees, clearinghouses and workers' compensation claims administrators shall implement procedures and utilize mechanisms to ensure the confidentiality of medical information submitted on electronic claims for payment of medical services. This security rule adapts the rules implementing the federal Health Insurance Portability and Accountability Act of 1996 for use in California workers' compensation electronic billing. (45 Code of Federal Regulations Subtitle A, Subchapter C, Part 164, Subchapter C, §§164.302-164.318 and Appendix.) These rules have been modified slightly for California workers' compensation electronic billing purposes. The changes include the following: this rule is applicable to "health care providers, health care facilities, ~~third party billers~~ billing agents/assignees, clearinghouses and workers' compensation claims administrators" instead of "covered entities;" this rule uses the term "medical information" instead of "protected health information;" this rule refers to "the security rule" instead of "this subpart;" this rule refers to "applicable privacy laws" instead of "requirements of subpart E [of HIPAA rule]." The numbering parallels the HIPAA regulation numbering for the convenience of the public.

2.0 § 164.302 Applicability.

Health care providers, health care facilities, ~~third party billers~~ billing agents/assignees, clearinghouses and workers' compensation claims administrators must comply with the applicable standards, implementation specifications, and requirements of this security rule with respect to electronic medical information.

3.0 § 164.304 Definitions.

As used in this security rule, the following terms have the following meanings:

Access means the ability or the means necessary to read, write, modify, or communicate data/information or otherwise use any system resource.

Administrative safeguards are administrative actions, and policies and procedures, to manage the selection, development, implementation, and maintenance of security measures to protect electronic medical information and to manage the conduct of the entity's workforce in relation to the protection of that information.

Authentication means the corroboration that a person is the one claimed.

Availability means the property that data or information is accessible and useable upon demand by an authorized person.

Confidentiality means the property that data or information is not made available or disclosed to unauthorized persons or processes.

Encryption means the use of an algorithmic process to transform data into a form in which there is a low probability of assigning meaning without use of a confidential process or key.

Facility means the physical premises and the interior and exterior of a building(s).

Information system means an interconnected set of information resources under the same direct management control that shares common functionality. A system normally includes hardware, software, information, data, applications, communications, and people.

Integrity means the property that data or information have not been altered or destroyed in an unauthorized manner.

Malicious software means software, for example, a virus, designed to damage or disrupt a system.

Password means confidential authentication information composed of a string of characters.

Physical safeguards are physical measures, policies, and procedures to protect an entity's electronic information systems and related buildings and equipment, from natural and environmental hazards, and unauthorized intrusion.

Security or Security measures encompass all of the administrative, physical, and technical safeguards in an information system.

Security incident means the attempted or successful unauthorized access, use, disclosure, modification, or destruction of information or interference with system operations in an information system.

Technical safeguards means the technology and the policy and procedures for its use that protect electronic medical information and control access to it.

User means a person or entity with authorized access.

Workstation means an electronic computing device, for example, a laptop or desktop computer, or any other device that performs similar functions, and electronic media stored in its immediate environment.

4.0 § 164.306 Security standards: General rules.

(a) General requirements. Health care providers, health care facilities, ~~third party billers~~billing agents/assignees, clearinghouses and workers' compensation claims administrators must do the following:

(1) Ensure the confidentiality, integrity, and availability of all electronic medical information the entity creates, receives, maintains, or transmits.

(2) Protect against any reasonably anticipated threats or hazards to the security or integrity of such information.

(3) Protect against any reasonably anticipated uses or disclosures of such information that are not legally permitted or required.

(4) Ensure compliance with the security rule by its workforce.

(b) Flexibility of approach.

(1) Health care providers, health care facilities, ~~third party billers~~billing agents/assignees, clearinghouses and workers' compensation claims administrators may use any security measures that allow the entity to reasonably and appropriately implement the standards and implementation specifications as specified in this the security rule.

(2) In deciding which security measures to use, health care providers, health care facilities, ~~third party billers~~billing agents/assignees, clearinghouses and workers' compensation claims administrators must take into account the following factors:

(i) The size, complexity, and capabilities of the entity.

(ii) The entity's technical infrastructure, hardware, and software security capabilities.

(iii) The costs of security measures.

(iv) The probability and criticality of potential risks to electronic medical information.

(c) Standards. Health care providers, health care facilities, ~~third party billers~~billing agents/assignees, clearinghouses and workers' compensation claims administrators must comply with the standards as provided in this section and in § 164.308, § 164.310, § 164.312, § 164.314, and § 164.316 with respect to all electronic medical information.

(d) Implementation specifications.

In this security rule:

(1) Implementation specifications are required or addressable. If an implementation specification is required, the word "Required" appears in parentheses after the title of the implementation specification. If an implementation specification is addressable, the word "Addressable" appears in parentheses after the title of the implementation specification.

(2) When a standard adopted in § 164.308, § 164.310, § 164.312, § 164.314, or § 164.316 includes required implementation specifications, health care providers, health care facilities, ~~third party billers~~billing agents/assignees, clearinghouses and workers' compensation claims administrators must implement the implementation specifications.

(3) When a standard adopted in § 164.308, § 164.310, § 164.312, § 164.314, or § 164.316 includes addressable implementation specifications, health care providers, health care facilities, ~~third party billers~~billing agents/assignees, clearinghouses and workers' compensation claims administrators must --

(i) Assess whether each implementation specification is a reasonable and appropriate safeguard in its environment, when analyzed with reference to the likely contribution to protecting the entity's electronic medical information; and

(ii) As applicable to the entity --

(A) Implement the implementation specification if reasonable and appropriate; or

(B) If implementing the implementation specification is not reasonable and appropriate --

(1) Document why it would not be reasonable and appropriate to implement the implementation specification; and

(2) Implement an equivalent alternative measure if reasonable and appropriate.

(e) Maintenance. Security measures implemented to comply with standards and implementation specifications adopted under this security rule must be reviewed and modified as needed to continue provision of reasonable and appropriate protection of electronic-medical information as described at § 164.316.

5.0 § 164.308 Administrative safeguards.

(a) Health care providers, health care facilities, ~~third party billers~~billing agents/assignees, clearinghouses and workers' compensation claims administrators -must, in accordance with § 164.306:

(1)(i) Standard: Security management process. Implement policies and procedures to prevent, detect, contain, and correct security violations.

(ii) Implementation specifications:

(A) Risk analysis (Required). Conduct an accurate and thorough assessment of the potential risks and vulnerabilities to the confidentiality, integrity, and availability of electronic medical information held by the entity.

(B) Risk management (Required). Implement security measures sufficient to reduce risks and vulnerabilities to a reasonable and appropriate level to comply with § 164.306(a).

(C) Sanction policy (Required). Apply appropriate sanctions against workforce members who fail to comply with the security policies and procedures of the entity.

(D) Information system activity review (Required). Implement procedures to regularly review records of information system activity, such as audit logs, access reports, and security incident tracking reports.

(2) Standard: Assigned security responsibility. Identify the security official who is responsible for the development and implementation of the policies and procedures required by this rule for the entity.

(3)(i) Standard: Workforce security. Implement policies and procedures to ensure that all members of its workforce have appropriate access to electronic medical information, as provided under paragraph (a)(4) of this section, and to prevent those workforce members who do not have access under paragraph (a)(4) of this section from obtaining access to electronic medical information.

(ii) Implementation specifications:

(A) Authorization and/or supervision (Addressable). Implement procedures for the authorization and/or supervision of workforce members who work with electronic medical information or in locations where it might be accessed.

(B) Workforce clearance procedure (Addressable). Implement procedures to determine that the access of a workforce member to electronic medical information is appropriate.

(C) Termination procedures (Addressable). Implement procedures for terminating access to electronic medical information when the employment of a workforce member ends or as required by determinations made as specified in paragraph (a)(3)(ii)(B) of this section.

(4)(i) Standard: Information access management. Implement policies and procedures for authorizing access to electronic medical information that are consistent with the applicable privacy laws.

(ii) Implementation specifications:

(A) Isolating health care clearinghouse functions (Required). If a health care clearinghouse is part of a larger organization, the clearinghouse must implement policies and procedures that protect the electronic medical information of the clearinghouse from unauthorized access by the larger organization.

(B) Access authorization (Addressable). Implement policies and procedures for granting access to electronic medical information, for example, through access to a workstation, transaction, program, process, or other mechanism.

(C) Access establishment and modification (Addressable). Implement policies and procedures that, based upon the entity's access authorization policies, establish, document, review, and modify a user's right of access to a workstation, transaction, program, or process.

(5)(i) Standard: Security awareness and training. Implement a security awareness and training program for all members of its workforce (including management).

(ii) Implementation specifications. Implement:

(A) Security reminders (Addressable). Periodic security updates.

(B) Protection from malicious software (Addressable). Procedures for guarding against, detecting, and reporting malicious software.

(C) Log-in monitoring (Addressable). Procedures for monitoring log-in attempts and reporting discrepancies.

(D) Password management (Addressable). Procedures for creating, changing, and safeguarding passwords.

(6)(i) Standard: Security incident procedures. Implement policies and procedures to address security incidents.

(ii) Implementation specification: Response and Reporting (Required). Identify and respond to suspected or known security incidents; mitigate, to the extent practicable, harmful effects of security incidents that are known to the covered entity; and document security incidents and their outcomes.

(7)(i) Standard: Contingency plan. Establish (and implement as needed) policies and procedures for responding to an emergency or other occurrence (for example, fire, vandalism, system failure, and natural disaster) that damages systems that contain electronic medical information.

(ii) Implementation specifications:

(A) Data backup plan (Required). Establish and implement procedures to create and maintain retrievable exact copies of electronic medical information.

(B) Disaster recovery plan (Required). Establish (and implement as needed) procedures to restore any loss of data.

(C) Emergency mode operation plan (Required). Establish (and implement as needed) procedures to enable continuation of critical business processes for protection of the security of electronic medical information while operating in emergency mode.

(D) Testing and revision procedures (Addressable). Implement procedures for periodic testing and revision of contingency plans.

(E) Applications and data criticality analysis (Addressable). Assess the relative criticality of specific applications and data in support of other contingency plan components.

(8) Standard: Evaluation. Perform a periodic technical and nontechnical evaluation, based initially upon the standards implemented under this rule and subsequently, in response to environmental or operational changes affecting the security of electronic medical information, that establishes the extent to which an entity's security policies and procedures meet the requirements of this security rule.

(b)(1) Standard: Business associate contracts and other arrangements. Health care providers, health care facilities, ~~third party billers~~ billing agents/assignees, clearinghouses and workers' compensation claims administrators, in accordance with § 164.306, may permit a business associate to create, receive, maintain, or transmit electronic medical information on the entity's behalf only if the entity obtains satisfactory assurances, in accordance with § 164.314(a) that the business associate will appropriately safeguard the information.

(2) This standard does not apply with respect to --

(i) The transmission by health care providers, health care facilities, ~~third party billers~~ billing agents/assignees, clearinghouses and workers' compensation claims administrators of electronic medical information to a health care provider concerning the treatment of an individual.

(3) A health care provider, health care facility, ~~third party biller~~ billing agent/assignee, clearinghouse and workers' compensation claims administrator that violates the satisfactory assurances it provided as a business associate of another entity will be in noncompliance with the standards, implementation specifications, and requirements of this paragraph and § 164.314(a).

(4) Implementation specifications: Written contract or other arrangement (Required). Document the satisfactory assurances required by paragraph (b)(1) of this section through a written contract or other arrangement with the business associate that meets the applicable requirements of § 164.314(a).

6.0 § 164.310 Physical safeguards.

Health care providers, health care facilities, ~~third party billers~~ billing agents/assignees, clearinghouses and workers' compensation claims administrators must, in accordance with § 164.306:

(a)(1) Standard: Facility access controls. Implement policies and procedures to limit physical access to its electronic information systems and the facility or facilities in which they are housed, while ensuring that properly authorized access is allowed.

(2) Implementation specifications:

(i) Contingency operations (Addressable). Establish (and implement as needed) procedures that allow facility access in support of restoration of lost data under the disaster recovery plan and emergency mode operations plan in the event of an emergency.

(ii) Facility security plan (Addressable). Implement policies and procedures to safeguard the facility and the equipment therein from unauthorized physical access, tampering, and theft.

(iii) Access control and validation procedures (Addressable). Implement procedures to control and validate a person's access to facilities based on their role or function, including visitor control, and control of access to software programs for testing and revision.

(iv) Maintenance records (Addressable). Implement policies and procedures to document repairs and modifications to the physical components of a facility which are related to security (for example, hardware, walls, doors, and locks).

(b) Standard: Workstation use. Implement policies and procedures that specify the proper functions to be performed, the manner in which those functions are to be performed, and the physical attributes of the surroundings of a specific workstation or class of workstation that can access electronic medical information.

(c) Standard: Workstation security. Implement physical safeguards for all workstations that access electronic medical information, to restrict access to authorized users.

(d)(1) Standard: Device and media controls. Implement policies and procedures that govern the receipt and removal of hardware and electronic media that contain electronic medical information into and out of a facility, and the movement of these items within the facility.

(2) Implementation specifications:

(i) Disposal (Required). Implement policies and procedures to address the final disposition of electronic medical information, and/or the hardware or electronic media on which it is stored.

(ii) Media re-use (Required). Implement procedures for removal of electronic medical information from electronic media before the media are made available for re-use.

(iii) Accountability (Addressable). Maintain a record of the movements of hardware and electronic media and any person responsible therefore.

(iv) Data backup and storage (Addressable). Create a retrievable, exact copy of electronic medical information, when needed, before movement of equipment.

7.0 § 164.312 Technical safeguards.

Health care providers, health care facilities, ~~third party billers~~ billing agents/assignees, clearinghouses and workers' compensation claims administrators must, in accordance with § 164.306:

(a)(1) Standard: Access control. Implement technical policies and procedures for electronic information systems that maintain electronic medical information to allow access only to those persons or software programs that have been granted access rights as specified in § 164.308(a)(4).

(2) Implementation specifications:

(i) Unique user identification (Required). Assign a unique name and/or number for identifying and tracking user identity.

(ii) Emergency access procedure (Required). Establish (and implement as needed) procedures for obtaining necessary electronic medical information during an emergency.

(iii) Automatic logoff (Addressable). Implement electronic procedures that terminate an electronic session after a predetermined time of inactivity.

(iv) Encryption and decryption (Addressable). Implement a mechanism to encrypt and decrypt electronic medical information.

(b) Standard: Audit controls. Implement hardware, software, and/or procedural mechanisms that record and examine activity in information systems that contain or use electronic medical information.

(c)(1) Standard: Integrity. Implement policies and procedures to protect electronic medical information from improper alteration or destruction.

(2) Implementation specification: Mechanism to authenticate electronic medical information (Addressable). Implement electronic mechanisms to corroborate that electronic medical information has not been altered or destroyed in an unauthorized manner.

(d) Standard: Person or entity authentication. Implement procedures to verify that a person or entity seeking access to electronic medical information is the one claimed.

(e)(1) Standard: Transmission security. Implement technical security measures to guard against unauthorized access to electronic medical information that is being transmitted over an electronic communications network.

(2) Implementation specifications:

(i) Integrity controls (Addressable). Implement security measures to ensure that electronically transmitted electronic medical information is not improperly modified without detection until disposed of.

(ii) Encryption (Addressable). Implement a mechanism to encrypt electronic medical information whenever deemed appropriate.

8.0 § 164.314 Organizational requirements.

(a)(1) Standard: Business associate contracts or other arrangements.

(i) The contract or other arrangement between the health care provider, health care facility, ~~third party biller~~ billing agent/assignee, clearinghouse and workers' compensation claims administrator and its business associate required by § 164.308(b) must meet the requirements of paragraph (a)(2)(i) or (a)(2)(ii) of this section, as applicable.

(ii) A health care provider, health care facility, ~~third party biller~~ billing agent/assignee, clearinghouse or workers' compensation claims administrator is not in compliance with the standards in paragraph (a) of this section if the entity knew of a pattern of an activity or practice of the business associate that constituted a material breach or violation of the business associate's obligation under the contract or other arrangement, unless the entity took reasonable steps to cure the breach or end the violation, as applicable, and, if such steps were unsuccessful --

(A) Terminated the contract or arrangement, if feasible; or

(B) If termination is not feasible, documented the reasons that make termination unfeasible and steps that will be taken to address the breach.

(2) Implementation specifications (Required).

(i) Business associate contracts. The contract between a health care provider, health care facility, ~~third party biller~~ billing agent/assignee, clearinghouse and workers' compensation claims administrator and a business associate must provide that the business associate will --

(A) Implement administrative, physical, and technical safeguards that reasonably and appropriately protect the confidentiality, integrity, and availability of the electronic medical information that it creates, receives, maintains, or transmits on behalf of the entity as required by this security rule;

(B) Ensure that any agent, including a subcontractor, to whom it provides such information agrees to implement reasonable and appropriate safeguards to protect it;

(C) Report to the entity any security incident of which it becomes aware;

(D) Authorize termination of the contract by the entity, if the entity determines that the business associate has violated a material term of the contract.

(ii) Other arrangements.

(A) When an entity and its business associate are both governmental entities, the entity is in compliance with paragraph (a)(1) of this section, if --

(1) It enters into a memorandum of understanding with the business associate that contains terms that accomplish the objectives of paragraph (a)(2)(i) of this section; or

(2) Other law (including regulations adopted by the entity or its business associate) contains requirements applicable to the business associate that accomplish the objectives of paragraph (a)(2)(i) of this section.

(B) If a business associate is required by law to perform a function or activity on behalf of an entity or to provide a service to an entity, the entity may permit the business associate to create, receive, maintain, or transmit electronic medical information on its behalf to the extent necessary to comply with the legal mandate without meeting the requirements of paragraph (a)(2)(i) of this section, provided that the entity attempts in good faith to obtain satisfactory assurances as required by paragraph (a)(2)(ii)(A) of this section, and documents the attempt and the reasons that these assurances cannot be obtained.

(C) The entity may omit from its other arrangements authorization of the termination of the contract by the entity, as required by paragraph (a)(2)(i)(D) of this section if such authorization is inconsistent with the statutory obligations of the entity or its business associate.

9.0 § 164.316 Policies and procedures and documentation requirements.

Health care providers, health care facilities, ~~third party billers~~ billing agents/assignees, clearinghouses and workers' compensation claims administrators must, in accordance with § 164.306:

(a) Standard: Policies and procedures. Implement reasonable and appropriate policies and procedures to comply with the standards, implementation specifications, or other requirements of this security rule, taking into account those factors specified in § 164.306(b)(2)(i), (ii), (iii), and (iv). This standard is not to be construed to permit or excuse an action that violates any other standard, implementation specification, or other requirements of this security rule. An entity may change its policies and procedures at any time, provided that the changes are documented and are implemented in accordance with this security rule.

(b)(1) Standard: Documentation.

(i) Maintain the policies and procedures implemented to comply with this security rule in written (which may be electronic) form; and

(ii) If an action, activity or assessment is required by this rule to be documented, maintain a written (which may be electronic) record of the action, activity, or assessment.

(2) Implementation specifications:

(i) Time limit (Required). Retain the documentation required by paragraph (b)(1) of this section for 6 years from the date of its creation or the date when it last was in effect, whichever is later.

(ii) Availability (Required). Make documentation available to those persons responsible for implementing the procedures to which the documentation pertains.

(iii) Updates (Required). Review documentation periodically, and update as needed, in response to environmental or operational changes affecting the security of the electronic medical information.

Attachment A to Security Rule

1.0 Security Standards: Matrix

Standards	Sections	Implementation Specifications
		(R)=Required, (A)=Addressable
Administrative Safeguards		
Security Management Process	164.308(a)(1)	Risk Analysis (R) Risk Management (R) Sanction Policy (R) Information System Activity Review (R)
Assigned Security Responsibility	164.308(a)(2)	(R)
Workforce Security	164.308(a)(3)	Authorization and/or Supervision (A) Workforce Clearance Procedure Termination Procedures (A)
Information Access Management	164.308(a)(4)	Isolating Health care Clearinghouse Function (R) Access Authorization (A) Access Establishment and Modification (A)
Security Awareness and Training	164.308(a)(5)	Security Reminders (A) Protection from Malicious Software (A) Log-in Monitoring (A) Password Management (A)
Security Incident Procedures	164.308(a)(6)	Response and Reporting (R)
Contingency Plan	164.308(a)(7)	Data Backup Plan (R) Disaster Recovery Plan (R) Emergency Mode Operation Plan (R)
		Testing and Revision Procedure (A) Applications and Data Criticality Analysis (A)
Evaluation	164.308(a)(8)	(R)
Business Associate Contracts and Other Arrangement	164.308(b)(1)	Written Contract or Other Arrangement (R)

Standards	Sections	Implementation Specifications
		(R)=Required, (A)=Addressable
Physical Safeguards		
Facility Access Controls	164.310(a)(1)	Contingency Operations (A) Facility Security Plan (A) Access Control and Validation Procedures (A) Maintenance Records (A)
Workstation Use	164.310(b)	(R)
Workstation Security	164.310(c)	(R)
Device and Media Controls	164.310(d)(1)	Disposal (R) Media Re-use (R) Accountability (A) Data Backup and Storage (A)
Technical Safeguards (see § 164.312)		
Access Control	164.312(a)(1)	Unique User Identification (R) Emergency Access Procedure (R) Automatic Logoff (A) Encryption and Decryption(A)
Audit Controls	164.312(b)	(R)
Integrity	164.312(c)(1)	Mechanism to Authenticate Electronic Medical Information (A)
Person or Entity Authentication	164.312(d)	(R)
Transmission Security	164.312(e)(1)	Integrity Controls (A) Encryption (A)

~~Appendix E Electronic and Digital Signature~~

~~An electronic or digital signature shall be recognized as valid if it conforms to the requirements for digital signatures under Government Code § 16.5 and the Secretary of State's implementing regulations at Title 2, California Code of Regulations §§ 22000— 22003, or if it conforms to other provisions of law. The Secretary of State's "Approved List of Digital Signature Certification Authorities" can be accessed on the web at: <http://www.sos.ca.gov/digsig/>.~~

~~Statute and Secretary of State Rules~~

~~1.0 California Government Code~~

~~1.1 Section § 16.5. Digital signatures~~

~~(a) In any written communication with a public entity, as defined in Section 811.2, in which a signature is required or used, any party to the communication may affix a signature by use of a digital signature that complies with the requirements of this section. The use of a digital signature shall have the same force and effect as the use of a manual signature if and only if it embodies all of the following attributes:~~

~~(1) It is unique to the person using it.~~

~~(2) It is capable of verification.~~

~~(3) It is under the sole control of the person using it.~~

~~(4) It is linked to data in such a manner that if the data are changed, the digital signature is invalidated.~~

~~(5) It conforms to regulations adopted by the Secretary of State. Initial regulations shall be adopted no later than January 1, 1997. In developing these regulations, the secretary shall seek the advice of public and private entities, including, but not limited to, the Department of Information Technology, the California Environmental Protection Agency, and the Department of General Services. Before the secretary adopts the regulations, he or she shall hold at least one public hearing to receive comments.~~

~~(b) The use or acceptance of a digital signature shall be at the option of the parties. Nothing in this section shall require a public entity to use or permit the use of a digital signature.~~

~~(c) Digital signatures employed pursuant to Section 71066 of the Public Resources Code are exempted from this section.~~

~~(d) "Digital signature" means an electronic identifier, created by computer, intended by the party using it to have the same force and effect as the use of a manual signature.~~

~~2.0 California Code of Regulations, Title 2~~

~~2.1 Section § 22000. Definitions.~~

~~(a) For purposes of this chapter, and unless the context expressly indicates otherwise:~~

~~(1) "Digitally signed communication" is a message that has been processed by a computer in such a manner that ties the message to the individual that signed the message.~~

~~(2) "Message" means a digital representation of information intended to serve as a written communication with a public entity.~~

~~(3) "Person" means a human being or any organization capable of signing a document, either legally or as a matter of fact.~~

~~(4) "Public entity" means the public entity as defined by California Government Code Section 811.2.~~

~~(5) "Signer" means the person who signs a digitally signed communication with the use of an acceptable technology to uniquely link the message with the person sending it.~~

~~(6) "Technology" means the computer hardware and/or software based method or process used to create digital signatures.~~

~~Note: Authority cited: Section 16.5, Government Code. Reference: Section 16.5, Government Code.~~

~~Section 22001. Digital Signatures Must Be Created by an Acceptable Technology.~~

~~(a) For a digital signature to be valid for use by a public entity, it must be created by a technology that is acceptable for use by the State of California.~~

~~Note: Authority cited: Section 16.5, Government Code. Reference: Section 16.5, Government Code.~~

~~**2.2 Section § 22002. Criteria for State to Determine if a Digital Signature Technology Is Acceptable for Use by Public Entities.**~~

~~(a) An acceptable technology must be capable of creating signatures that conform to requirements set forth in California Government Code Section 16.5, specifically,~~

~~(1) It is unique to the person using it;~~

~~(2) It is capable of verification;~~

~~(3) It is under the sole control of the person using it;~~

~~(4) It is linked to data in such a manner that if the data are changed, the digital signature is invalidated;~~

~~(5) It conforms to Title 2, Division 7, Chapter 10 of the California Code of Regulations.~~

~~Note: Authority cited: Section 16.5, Government Code. Reference: Section 16.5, Government Code.~~

~~**2.3 Section § 22003. List of Acceptable Technologies.**~~

~~(a) The technology known as Public Key Cryptography is an acceptable technology for use by public entities in California, provided that the digital signature is created consistent with the provisions in Section 22003(a)1-5.~~

~~(1) Definitions — For purposes of Section 22003(a), and unless the context expressly indicates otherwise:~~

~~(A) "Acceptable Certification Authorities" means a certification authority that meets the requirements of either Section 22003(a)6(C) or Section 22003(a)6(D).~~

~~(B) "Approved List of Certification Authorities" means the list of Certification Authorities approved by the Secretary of State to issue certification for digital signature transactions involving public entities in California.~~

~~(C) "Asymmetric cryptosystem" means a computer algorithm or series of algorithms which utilize two different keys with the following characteristics:~~

~~(i) one key signs a given message;~~

~~(ii) one key verifies a given message; and,~~

~~(iii) the keys have the property that, knowing one key, it is computationally infeasible to discover the other key.~~

~~(D) "Certificate" means a computer based record which:~~

~~(i) identifies the certification authority issuing it;~~

~~(ii) names or identifies its subscriber;~~

~~(iii) contains the subscriber's public key; and~~

~~(iv) is digitally signed by the certification authority issuing or amending it, and~~

~~(v) conforms to widely used industry standards, including, but not limited to ISO x.509 and PGP certificate standards.~~

~~(E) "Certification Authority" means a person or entity that issues a certificate, or in the case of certain certification processes, certifies amendments to an existing certificate.~~

~~(F) "Key pair" means a private key and its corresponding public key in an asymmetric cryptosystem. The keys have the property that the public key can verify a digital signature that the private key creates.~~

~~(G) "Practice statement" means documentation of the practices, procedures and controls employed by a Certification Authority.~~

~~(H) "Private key" means the key of a key pair used to create a digital signature.~~

~~(I) "Proof of Identification" means the document or documents presented to a Certification Authority to establish the identity of a subscriber.~~

~~(J) "Public key" means the key of a key pair used to verify a digital signature.~~

~~(K) "Subscriber" means a person who:~~

~~(i) is the subject listed in a certificate;~~

~~(ii) accepts the certificate; and~~

~~(iii) holds a private key which corresponds to a public key listed in that certificate.~~

~~(2) California Government Code s16.5 requires that a digital signature be 'unique to the person using it'. A public key based digital signature may be considered unique to the person using it, if:~~

~~(A) The private key used to create the signature on the document is known only to the signer, and~~

~~(B) the digital signature is created when a person runs a message through a one-way function, creating a message digest, then encrypting the resulting message digest using an asymmetrical cryptosystem and the signer's private key, and,~~

~~(C) although not all digitally signed communications will require the signer to obtain a certificate, the signer is capable of being issued a certificate to certify that he or she controls the key pair used to create the signature, and~~

~~(D) it is computationally infeasible to derive the private key from knowledge of the public key.~~

~~(3) California Government Code s16.5 requires that a digital signature be 'capable of verification'. A public key based digital signature is capable of verification if:~~

~~(A) the acceptor of the digitally signed document can verify the document was digitally signed by using the signer's public key to decrypt the message; and~~

~~(B) if a certificate is a required component of a transaction with a public agency, the issuing Certification Authority, either through a certification practice statement or through the content of the certificate itself, must identify which, if any, form(s) of identification it required of the signer prior to issuing the certificate.~~

~~(4) California Government Code s16.5 requires that the digital signature remain 'under the sole control of the person using it'. Whether a signature is accompanied by a certificate or not, the person who holds the key pair, or the subscriber identified in the certificate, assumes a duty to exercise reasonable care to retain control of the private key and prevent its disclosure to any person not authorized to create the subscriber's digital signature pursuant to Evidence Code Section 669:~~

~~(5) The digital signature must be linked to the message of the document in such a way that if the data are changed, the digital signature is invalidated.~~

~~(6) Acceptable Certification Authorities~~

~~(A) The California Secretary of State shall maintain an "Approved List of Certification Authorities" authorized to issue certificates for digitally signed communication with public entities in California.~~

~~(B) Public entities shall only accept certificates from Certification Authorities that appear on the "Approved List of Certification Authorities" authorized to issue certificates by the California Secretary of State.~~

~~(C) The Secretary of State shall place Certification Authorities on the "Approved List of Certification Authorities" after the Certification Authority provides the Secretary of State with a copy of an unqualified performance audit performed in accordance with standards set in the American Institute of Certified Public Accountants (AICPA) Statement on Auditing Standards No. 70 (S.A.S. 70) "Reports on the Processing of Service Transactions by Service Organizations" (1992) to ensure that the Certification Authorities' practices~~

~~and policies are consistent with the Certifications Authority's stated control objectives. The AICPA Statement on Auditing Standards No. 70 (1992) is hereby incorporated by reference.~~

~~(i) Certification Authorities that have been in operation for one year or less shall undergo a SAS 70 Type One audit—A Report of Policies and Procedures Placed in Operation, receiving an unqualified opinion.~~

~~(ii) Certification Authorities that have been in operation for longer than one year shall undergo a SAS 70 Type Two audit—A Report Of Policies And Procedures Placed In Operation And Test Of Operating Effectiveness, receiving an unqualified opinion.~~

~~(iii) To remain on the "Approved List of Certification Authorities" a Certification Authority must provide proof of compliance with Section 20003(a)(6)(C)(ii) to the Secretary of State every two years after initially being placed on the list.~~

~~(D) In lieu of completing the auditing requirement in Section 22003(a)(6)(C), Certification Authorities may be placed on the "Approved List of Certification Authorities" upon providing the Secretary of State with proof of accreditation that has been conferred by a national or international accreditation body that the Secretary of State has determined utilizes accreditation criteria that are consistent with the requirements of Section 22003(a)(1) (5).~~

~~(i) Certification Authorities shall be removed from the "Approved List of Acceptable Certifications Authorities" unless they provide current proof of accreditation to the Secretary of State at least once per year.~~

~~(ii) If the Secretary of State is informed that a Certification Authority has had its accreditation revoked, the Certification Authority shall be removed from the "Approved List of Certification Authorities" immediately.~~

~~(b) The technology known as "Signature Dynamics" is an acceptable technology for use by public entities in California, provided that the signature is created consistent with the provisions in Section 22003(b)(1) (5).~~

~~(1) Definitions—For the purposes of Section 22003(b), and unless the context expressly indicates otherwise:~~

~~(A) "Handwriting Measurements" means the metrics of the shapes, speeds and/or other distinguishing features of a signature as the person writes it by hand with a pen or stylus on a flat surface.~~

~~(B) "Signature Digest" is the resulting bit-string produced when a signature is tied to a document using Signature Dynamics.~~

~~(C) "Expert" means a person with demonstrable skill and knowledge based on training and experience who would qualify as an expert pursuant to California Evidence Code s720.~~

~~(D) "Signature Dynamics" means measuring the way a person writes his or her signature by hand on a flat surface and binding the measurements to a message through the use of cryptographic techniques.~~

~~(2) California Government Code s16.5 requires that a digital signatures be 'unique to the person using it.' A signature digest produced by Signature Dynamics technology may be considered unique to the person using it, if:~~

~~(A) the signature digest records the handwriting measurements of the person signing the document using signature dynamics technology, and~~

~~(B) the signature digest is cryptographically bound to the handwriting measurements, and~~

~~(C) after the signature digest has been bound to the handwriting measurements, it is computationally infeasible to separate the handwriting measurements and bind them to a different signature digest.~~

~~(3) California Government Code s16.5 requires that a digital signature be capable of verification. A signature digest produced by signature dynamics technology is capable of verification if:~~

~~(A) the acceptor of the digitally signed message obtains the handwriting measurements for purposes of comparison, and~~

~~(B) if signature verification is a required component of a transaction with a public entity, the handwriting measurements can allow an expert handwriting and document examiner to assess the authenticity of a signature.~~

~~(4) California Government Code s16.5 requires that a digital signature remain 'under the sole control of the person using it'. A signature digest is under the sole control of the person using it if:~~

~~(A) the signature digest captures the handwriting measurements and cryptographically binds them to the message directed by the signer and to no other message, and~~

~~(B) the signature digest makes it computationally infeasible for the handwriting measurements to be bound to any other message.~~

~~(5) The signature digest produced by signature dynamics technology must be linked to the message in such a way that if the data in the message are changed, the signature digest is invalidated.~~

~~2.4 Section § 22004. Provisions for Adding New Technologies to the List of Acceptable Technologies.~~

~~(a) Any individual or company can, by providing a written request that includes a full explanation of a proposed technology which meets the requirements of Section 22002, petition the California Secretary of State to review the technology. If the Secretary of State determines that the technology is acceptable for use with the state, the Secretary of State shall adopt regulation(s), pursuant to the Administrative Procedure Act, which would add the proposed technology to the list of acceptable technologies in Section 22003.~~

~~(b) The Secretary of State has 180 calendar days from the date the request is received to review the petition and inform the petitioner, in writing, whether the technology is accepted or rejected. If the petition is rejected, the Secretary of State shall provide the petitioner with the reasons for the rejection.~~

~~(1) If the proposed technology is rejected, the petitioner can appeal the decision through the Administrative Procedures Act ([Government Code Section 11500 et seq.](#)).~~

Note: Authority cited: [Section 16.5, Government Code](#). Reference: [Section 16.5, Government Code](#).